



Model no.: GMT-P1

User's Manual

110611010006
V20.02.01_01

©2015, Shenzhen General Measure Technology Co., Ltd reserves all copyright.

Without permission from Shenzhen General Measure Technology Co., Ltd.,

Any corporations or person must not copy, spread, record or translate into other language by any forms.

Our company reserved the right to update user's manual without additional notice to customers by reason of update, so please visit our website or contact with our service person to get update information.

Website: <http://www.szgmt.com.cn>

CONTENTS

1	General Description.....	1
1.1	Functions and Characteristics.....	1
1.2	Front Panel.....	2
1.3	Technical Specifications.....	4
1.3.3	Digital:.....	5
2	Installation and Wiring.....	6
2.1	Connection of Power Supply.....	6
2.2	Connection of Load Cell.....	6
2.2.1	6 wires connection.....	7
2.3	I/O terminals.....	8
2.4	Optional Expansion Board Output.....	9
2.4.1	Serial Interface RS485 Output.....	9
2.4.2	Serial Interface RS232 output (Optional).....	11
3	Calibration.....	12
3.1	Instruction.....	12
3.2	Flow Chart of Calibration.....	13
3.3	Millivolt Value Display.....	18
3.4	Calibration with Weights.....	19
3.5	No weight calibration.....	19
3.5.1	No weight zero Calibration.....	19
3.5.2	No weight gain Calibration.....	20
	Historical gain calibration.....	21

Sensitivity and gain calibration range.....	22
3.6 Calibration Switch for Communication Interface.....	23
3.7 Explanation for Calibration Parameters.....	23
4 Working Parameters Setting.....	25
4.1 Flow Chart of Working Parameters Setting.....	25
4.2 Parameter Setting Method.....	26
4.3 Descriptions of Operation Parameters.....	28
4.4 Set point parameters.....	31
5 I/O Definition.....	33
5.1 I/O Definition.....	33
5.2 I/O testing.....	35
6 Serial Communication.....	37
6.1 r-Cont.....	37
6.2 r-SP1.....	38
6.2.1 Parameters Code Chart.....	38
6.2.2 Error Code Explanation.....	39
6.2.3 Command.....	40
6.3 tt TOLEDO Protocol.....	47
6.4 Cb920.....	49
6.5 rECont.....	50
6.6 rEREAD.....	51
6.7 Modbus.....	52
6.7.1 Modbus communication address.....	53

7 Ethernet communication.....	61
8 Password Input and Setting Reset.....	62
8.1 Password Input.....	62
8.2 Password Setting.....	62
8.3 Factory Reset.....	64
9 Display Testing.....	66
10 Errors and Alarm Messages.....	67
11. Indicator model user-defined function.....	68
12 Dimension of Indicator.....	69

1 General Description

GMT-P1 digital indicator is specially designed for weight transmitting in industrial fields.

This indicator has the features of small volume, plenty communicating commands, stable performance, easy operation and practicability. It can be widely applied to concrete and bitumen mixing equipment, metallurgy furnace and converter, chemical industry and feed, etc. .

1.1 Functions and Characteristics

- Small volume, unique design, easy operation
- Applicable to all kinds of resistance strain gauge bridge load cell
- Front panel numerical calibration
- Multilevel of digital filter
- Automatic zero -tracking
- Automatically zero when powered on
- 4 set points
- 1 input and 2 outputs
- Optional communication interface:RS232 or RS485
- Calibration via serial interface or Ethernet

1.2 Front Panel

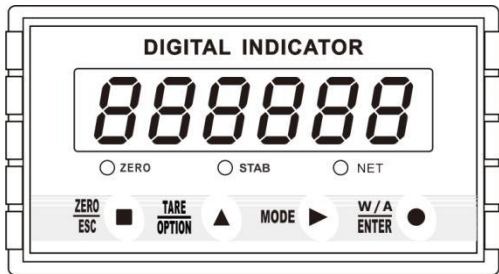



Main Display: 6 digits, for displaying weight and the information of parameters.

Status Indicator Lamp:

- **ZERO:** Light on when present weight is within $0 \pm 1/4d$. the state of I10.
- **STAB:** Light on when changes of weight values are within the range of motion detecting during motion detecting time.
- **NET:** Light on when indicator is in net weight status.

Keypad:

 : Zero/Esc, exit from current operation or go previous. Long press the ZERO button to calibrate the ZERO point function. The calibration range of the ZERO point in the main interface is limited by the ZERO clearing range, and cannot exceed the zeroing range, but it is not limited by

 : Scroll optional values of parameter and to make flashing digit increase 1 while data inputting. Long press Tare key will proceed data transmission, and the light will be flicker, and update the F1.8 parameters

 : Function selecting key, make flashing position move to the right digit when data inputting.

 : Confirming Key. Confirm setting parameters or calibration and input data.

Note: Under the status of gross weight, user could remove tare by pressing OPTION key, and if press Esc key in net weight mode, it will add tare weight, while it is zeroing under the status of net weight. It will show net weight value after tare, meanwhile the NET light is on.

1.3 Technical Specifications

1.3.1 Common:

Power supply: **DC24V±5%**

Working temperature: **-10~40℃**

Max humidity: **90%R.H without dew**

Power consumption: **About 10W**

Dimension: **105×89×57 (mm)**

1.3.2 Analog:

Load cell power: **DC5V 200mA (MAX)**

Input impedance: **10MΩ**

Zero steady range: **0.00~12mV(Load cell 3mV/V)**

Input sensitivity: **0.01uV/d**

Input range: **0.00~15mV(Load cell 3mV/V)**

Transfer mode: **Sigma - Delta**

A/D conversion speed: **15, 30, 60, 120, 480, 960 times/sec**

Non-linearity: **0.01% F.S**

Gain drift: **10PPM/℃**

Display Precision: **1,000,000d**

1.3.3 Digital:

Weight display: **6 digits red high-brightness LED**

Minus display: “-”

Overload display: “**OFL**”

Decimal point: **5 kinds (optional)**

Function keys: **4 keys soniferous keypad**

2 Installation and Wiring

2.1 Connection of Power Supply

GMT-P1 digital indicator connects DC24V power supply as follows:

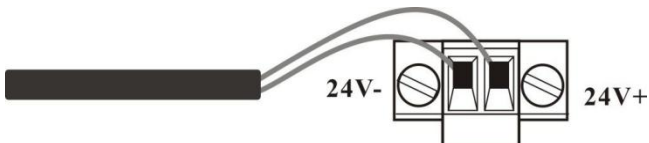

Power supply connection

2.2 Connection of Load Cell

GMT-P1 digital indicator connects bridge type resistance strain gauge load cells by 6 wires or 4 wires as follows. When you use 4-wired load cells, you must bridge the SN+ with EX+ and bridge the SN- with EX-.

The signal definition of each port of the load cell connector is as follows:

EX+: Excitation+ **EX-:** Excitation- **SN+:** Sense+ **SN-:** Sense- **SIG+:** Signal+ **SIG-:** Signal-

6 wires	EX+	SN+	EX-	SN-	SIG+	SIG-	Shield
4 wires	EX+		EX-		SIG+	SIG-	Shield

2.2.1 6 wires connection

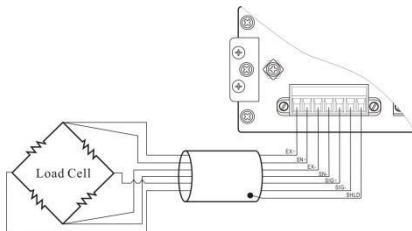

Note:

1. As load cell output sensitive analog signal, please use shield cable to separate with other cables, especially AC power.
2. 4 wires connection is suitable for short distance and stable temperature or low precision field, otherwise use 6 wires connection.
3. For more load cells parallel connection, their sensitivity (mV/V) should be same.

2.3 I/O terminals

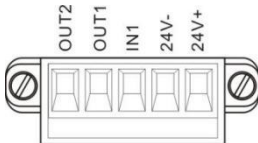

I/O tolerant definition as follows:

Output		Input	
OUT1	Stable	IN1	Reset all
OUT2	OFL		

Indicator input terminal connection:

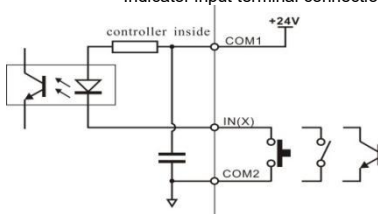

Indicator input terminal connection:

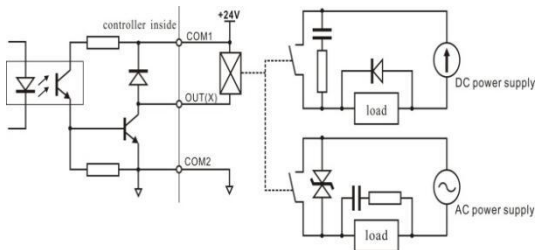

2.4 Optional Expansion Board Output

GMT-P1 digital indicator supports RS232 or RS485 as optional output function, please confirm it when place orders.

2.4.1 Serial Interface RS485 Output

Serial Interface RS485 output is optional, please refer to chapter 6.0 for communication protocol.

RS485 serial interface connection:

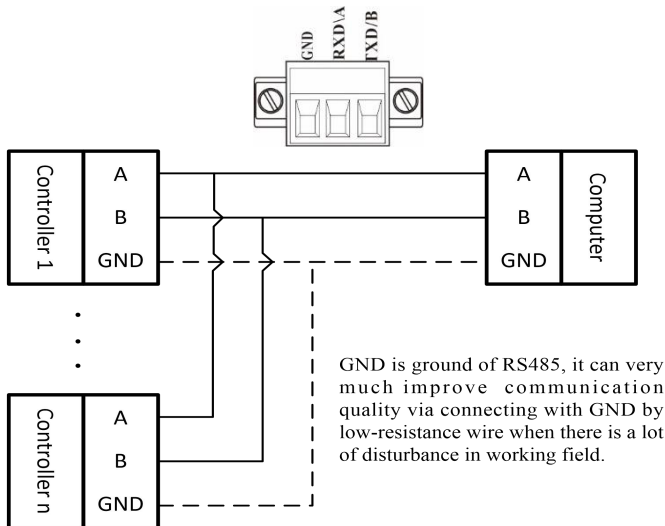

2.4.2 Serial Interface RS232 output (Optional)

RS232 serial interface connection:

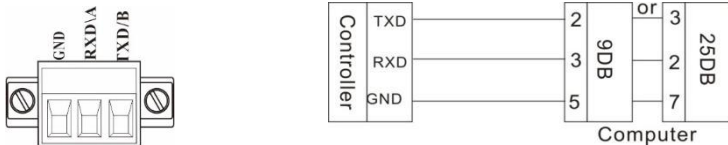

3 Calibration

3.1 Instruction

- (1) Calibration procedure must be executed when a GMT-P1 indicator is put in use at the first time, the preset parameters may no longer meet the user's needs, and any part of the weighing system was changed. Position of decimal point, minimum division, maximum capacity, zero, and gain can be set and confirmed through calibration.

- (2) If you want to set only one parameter, please press  to save

parameter's value and then press  to exit.



- (3) Please see section **3.7** for parameters' instruction.

(4) Please record each value in the blank table in section 3.4 during calibration for the emergency use in future.

(5) See chapter 9 for error alarm message that may be displayed during calibration.

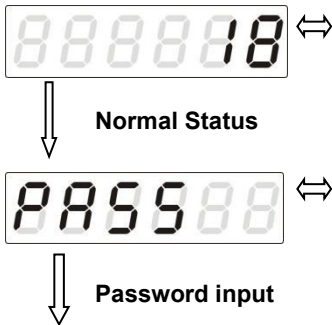
3.2 Flow Chart of Calibration



1. Under this status, press  (twice), indicator will display **CAL**, then press  to enter password input.
2. After password is input, the indicator will display **CALON** for one second, then go to next step.



Decimal point



Min. division



Max. capacity



3. Press $\frac{\text{TARE}}{\text{OPTION}}$ ▲ to select a desired value for decimal point among **0**, **0.0**, **0.00**, **0.000** and **0.0000**, and then press $\frac{\text{W/A}}{\text{ENTER}}$ ● to save it and enter next step. If there's no need to change the value, press $\frac{\text{W/A}}{\text{ENTER}}$ ● directly to enter next step.



4. Press $\frac{\text{TARE}}{\text{OPTION}}$ ▲ to select a desired value for min. division among **1**, **2**, **5**, **10**, **20** and **50**, and then to save it and enter next step. If there's no need to change the Min,division, then press $\frac{\text{W/A}}{\text{ENTER}}$ ● directly to enter next step.



5. Input max. capacity(\leq min. division \times **1000000**), press $\frac{\text{W/A}}{\text{ENTER}}$ ● to save it and enter Millivolt value display interface. If there's no need to change the max. capacity value, then press $\frac{\text{W/A}}{\text{ENTER}}$ ● directly to enter Millivolt display interface.



6. Under this status, press $\frac{W/A}{ENTER}$ ● to enter zero calibration.
 Display value near the output value in millivolt between **SIG+ / SIG-** of load cell.
 See section 3.3 for details about this function.



Millivolt value display



7. Unloaded scale first, when **STAB** lamp is on, press $\frac{W/A}{ENTER}$ ● to finish zero calibration.
 If there's no need to calibrate zero, press $\frac{ZERO}{ESC}$ ■ directly to enter gain calibration.

Zero calibration

8. The process of gain calibration is as follows. If there's no need to do gain calibration, press



directly to enter serial ports calibration switch setting.

Gain Calibration

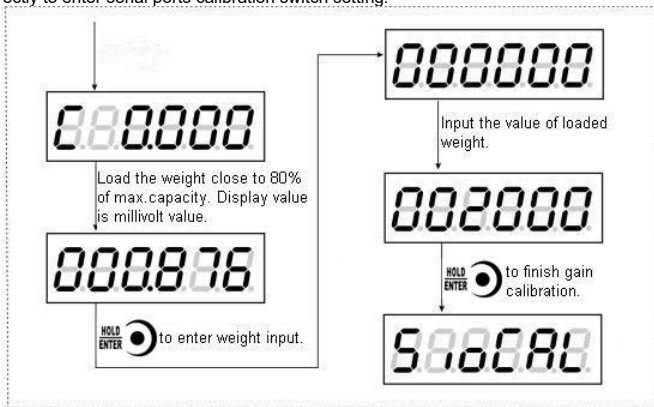

Serial ports
calibration switch

Password setting



Normal status



9. Press $\frac{W/A}{ENTER}$ ● to enter setting interface,
 press $\frac{TARE}{OPTION}$ ▲ to choose the switch position,
 press $\frac{W/A}{ENTER}$ ● to set password. If don't need to set
 switch position, then press $\frac{ZERO}{ESC}$ ◻ to enter password
 setting.

10. See section 7.2 for reference to set password.
 If there's no need to set password,
 press $\frac{ZERO}{ESC}$ ◻ directly to go back to normal
 status.

3.3 Millivolt Value Display

This function is mainly used for system test, position-error test for weighing mechanism and linearity test for load cell.

1. System Test

(1) If display data changes with loaded weight changes, it shows that connection of load cell is correct and weighing mechanism works well.

(2) If display value is OFL (or -OFL), it means that loaded weight on load cells is too large (or too small). Please unload the weight (or load more), if display value is still OFL (or -OFL), the possible reasons are as follows:

- There is something wrong with weighing mechanism, please check and clear.
- The connection of load cell is incorrect, please check and clear.
- Load cells may be damaged, please replace.

2. Position-error Test for Weighing Mechanism

Load a same weight on each corner of weighing mechanism and record displayed millivolt value respectively. If differences among these values are obvious, please adjust weighing mechanism.

3. Linearity Test for Load Cell

Load same weight for several times, and record displayed value every time. If one or two values are obviously much larger or smaller than any others, it means that the linearity of load cell is bad.

***NOTE:** Press  to zero every time before weight is loaded.

3.4 Calibration with Weights

In Chapter 3.2, steps 7 and 8 in the calibration flow chart are operation instructions of calibration zero point and calibration gain with weights

During calibration with weight, please record the zero millivolt value, gain millivolt value and the loaded weight value in the blank table below. If it is not convenient to load a weight to calibrate, these values can be used for calibration without weights.

	Zero millivolt value(mV)	Gain millivolt value(mV)	Loaded Weight	Date	Remarks
1					
2					
3					
4					
5					

3.5 No weight calibration

3.5.1 No weight zero Calibration

When the mechanism is calibrated with weights, the millivolt value corresponding to the empty balance should be recorded. Zero calibration is accomplished by manually entering historical values.

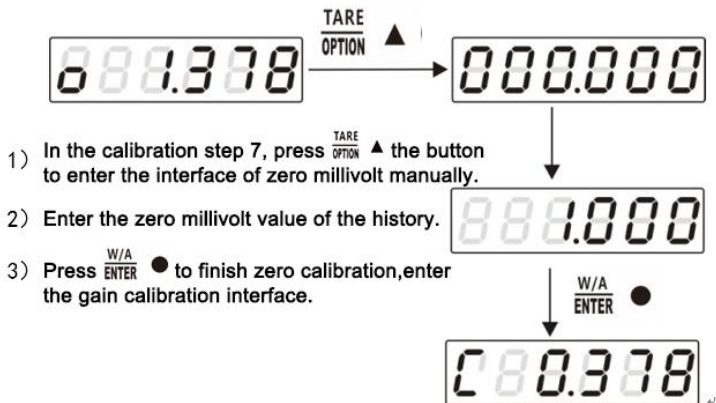

3.5.2 No weight gain Calibration

There are two methods for weighting - free calibration gain

- 1) Historical calibration: Gain calibration by entering historical record values
- 2) Theoretical calibration: Calibrate through sensor sensitivity and maximum range value of input mechanism (the sum of the average value of input sensitivity and

maximum range when multiple sensors are connected)

Historical gain calibration

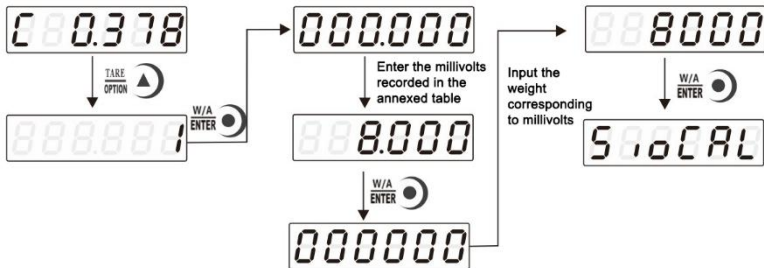

- 1) In gain calibration interface, press **TARE OPTION** ▲ , and the interface displays 1. Press **W/A ENTER** ● to enter the manual gain millivolt input interface and enter the historical millivolt value.

- 2) Press $\frac{W/A}{ENTER}$ ● save to enter the weight input interface and enter the weight value corresponding to the millivolt number.
- 3) Press $\frac{W/A}{ENTER}$ ● save to complete gain calibration and enter the serial port calibration switch.

Sensitivity and gain calibration range

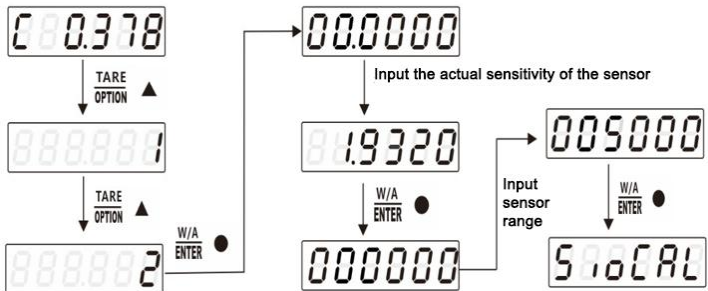

- 1) In gain calibration interface, press twice $\frac{\text{TARE}}{\text{OPTION}}$ ▲ to enter and choose "2" press enter interface for manual input of sensor sensitivity and input the sensitivity of the actual sensor.
- 2) Press $\frac{\text{W/A}}{\text{ENTER}}$ ● , enter the maximum range input interface and input sensor range.
- 3) Press $\frac{\text{W/A}}{\text{ENTER}}$ ● , complete gain calibration and enter serial port calibration switch.

3.6 Calibration Switch for Communication Interface

When calibrate the transmitter through serial port(Rs、 SP1 or Modbus), must set to "ON" status for the calibration switch for communication interface.

3.7 Explanation for Calibration Parameters

Symbol	Parameter	Types	Value of parameter	Default
Pt	Decimal Point	5	0 0.0 0.00 0.000 0.0000	0
1d	Min. Division	6	1 2 5 10 20 50	1
CP	Max. Capacity		$\leq \text{Min. Division} \times 100000$	10000
t	Millivolt Value			

o	Zero			
C	Gain			
SIOCAL	Switch for Calibration via serial interface			OFF
PASS	Password Setting			00000

Log Table for Calibration Parameters

Parameter	Calibrated Value	Date	Remarks
Decimal Point			
Min. Division			
Max. Capacity			
Load cell sensitivity			
Password			

4 Working Parameters Setting

4.1 Flow Chart of Working Parameters Setting

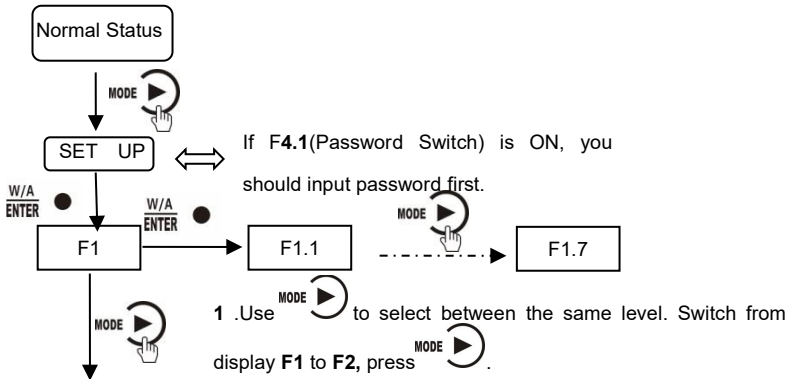

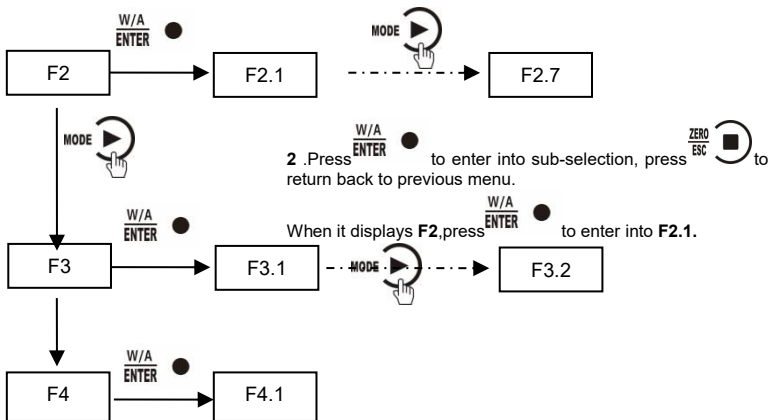

4.2 Parameter Setting Method

GMT-P1 has 2 kinds of working parameters: Selection type and data type. For

selection type parameters, press **TARE OPTION** ▲ to choose. For data type parameter in

parameter interface, press **MODE** ► to choose digit position, press **TARE OPTION** ▲ to choose value.

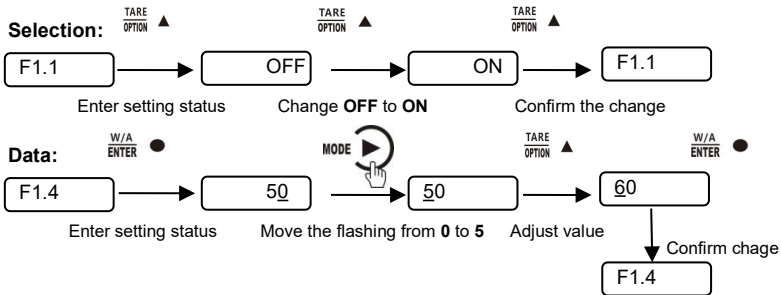

4.3 Descriptions of Operation Parameters

Code	Default	Description
F1	Null	The first major term of working parameter.
F1.1	OFF	Switch for Auto-Zeroing when power-on, OFF: disabled ON: enabled
F1.2	0	Zero-tracking Range (0~9d optional) . This parameter is for automatic calibration, disabled when is set "0".
F1.3	0	Motion Detecting Range (0~9d optional) It is stable if the change is within range.
F1.4	50	Zeroing Range (00%~99% of Maximum capacity)
F1.5	5	Digital filtering parameter: (1-9 as optional) 0: without filtering 9: strongest digital filtering
F1.6	0	VF-Filter 0: without filtering 9: strongest digital filtering(1-9 as optional)
F1.7	0	A/D conversion rate: 120,480,960,15,30,60 as optional

F1.8	0	0 : NET indicating net weight ; 1 : NET indicating communication
F2	Null	The second major term of working parameter.
F2.1	01	Scale no., indicator no.
F2.2	38400	Baud rate of serial port:1200 / 2400 / 4800 / 9600 / 19200 / 38400 / 57600
F2.3	Modbus-R TU	Serial ports communication mode: Modbus-RTU: MODBUS RTU mode; r-Cont:SP1 continuous mode; r-SP1: SP1 command mode; tt:TOLEDOcontinuous mode; Cb920: Cb920 continuous mode. rE-Cont:rE continuous mode; rE- rEAd:rEcommand mode;
F2.4	8-E-1	Data format: 7-E-1: 7 data bit, even parity check, 1 stop bit; 7-O-1: 7data bit, odd parity check, 1 stop bit; 8-E-1: 8 data bit, even parity check, 1 stop bit; 8-O-1: 8 data bit, odd parity check, 1 stop bit;

		8-n-1: 8 data bits, no parity check, 1 stop bit; 8-n-2: 8 data bits, no parity check, 2 stop bits;
F2.5	HiLo	MODBUS dual-byte register storage turn, Hi Lo: High byte in the front, low byte at the back; Lo Hi: Low byte in the front, high byte at the back
F2.6	nONE	Cont mode automatic sending time interval
F2.7	0	tt(TOLEDO continuous mode) If send the checksum. 0: not send, 1: send.
F3	Null	The third major term of working parameter.
F3.1	0-255	The first paragraph of IP, initial vale 192
F3.2	0-255	The second paragraph of IP, initial vale 168
F3.3	0-255	The third paragraph of IP, initial vale 1
F3.4	0-255	The fourth paragraph of IP, initial vale 1
F3.5	1-65534	Modbus-TCP communication port no., initial value 502
F3.6		Ethernet communication mode 0: b Tcp; 1: Cont
F4	Null	The fourth major term of working parameter.
F4.1	OFF	Parameters password setting switch.
F4.2	000000	Parameters password setting: Valid when F4.1 is ON
F5	Null	Parameter setting refer the 5 th term

F5.1	1.00000	Weight correction factor K, weight correction factor K = Expected weight/current weight range: 0-9.99999 When the weight is calibrated (gain) or the calibration parameter is reset, the value changes to the default value of 1.00000
-------------	----------------	--

4.4 Set point parameters

Code	Default	Description
P1-P4	Null	The first term of working parameters
PX.1	OFF	Change of state if need stable
PX.2	0.0	Change of state minimum duration
PX.3	P1.3=1 P2.3=5 P3.3=0 P4.3=0	Condition of validity: 0: forbid; 1: < Less than; when the weight is less than Fx. 4, the output is valid, otherwise it's invalid 2: <= Less than or equal to; when the weight is less than or equal to Fx. 4, the output is valid; otherwise, it is invalid. 3: == Equal; when the weight is equal to Fx. 4, the output is valid; otherwise, it is invalid

		<p>4: \geq; Bigger than or equal to; when the weight is greater than Fx. 4, the output is valid, otherwise, it is invalid</p> <p>5: $>$ Bigger than; when the weight is greater than Fx. 4, the output is valid, otherwise, it is invalid</p> <p>6: \neq not equal to; when the weight is not equal to Fx. 4, the output is valid, otherwise, it is invalid</p> <p>7: $_<>_$ Outside the interval, When the weight is less than FX.4 or more than Fx. 5, the output is valid, otherwise, it is invalid</p> <p>8: $_< _>=$ In the interval, when the weight is bigger than or equal to Fx. 4 and less than or equal to Fx. 5, the output is valid, otherwise, it is invalid</p> <p>9: external trigger. If it's IO, do 1 state change for 1 trigger, if it's command, then decide according to valid or invalid command.</p>
PX.4	0	Set value 1; 0 ~ 999999 can be set
PX.5	0	Set value 2; 0 ~ 999999 can be set

Set point has 4 major terms which are user defined.

5 I/O Definition

5.1 I/O Definition

Output/Input code table:

Output		
Code	Definition	Description
O0	None	No definition
O1	Stable	Effective output in stable status.
O2	Overflow	Effective output when overflow.
O3	Sp1	Effective output when set point 1 status output.
O4	Sp2	Effective output when set point 2 status output.
O5	Sp3	Effective output when set point 3 status output.
O6	Sp4	Effective output when set point 4 status output.

Input		
Code	Definition	Description
I0	None	No definition
I1	Zeroing	Effective input for zeroing, pulse input signals
I2	Sp1	If this signal is valid, Sp1 status will be regarded as invalid. Output valid state when comparison condition turns to invalid, and be effective again.
I3	Sp2	If this signal is valid, Sp2 status will be regarded as invalid. Output valid state when comparison condition turns to invalid, and be effective again.
I4	Sp3	If this signal is valid, Sp3 status will be regarded as invalid. Output valid state when comparison condition turns to invalid, and be effective again.
I5	Sp4	If this signal is valid, Sp4 status will be regarded as invalid. Output valid state when comparison condition turns to invalid, and be effective again.
I6	Reset all	Reset all parameter value when this signal is valid.

I7	Tare/Add tare	Tare when the first valid signal. Add tare when second.
I8	Tare	Tare when the signal is valid.
I9	Add tare	Add tare when the signal is valid.
I10	I/O define	IO calibration lock, when I10 is defined, cannot be calibrated if the input is invalid.

5.2 I/O testing

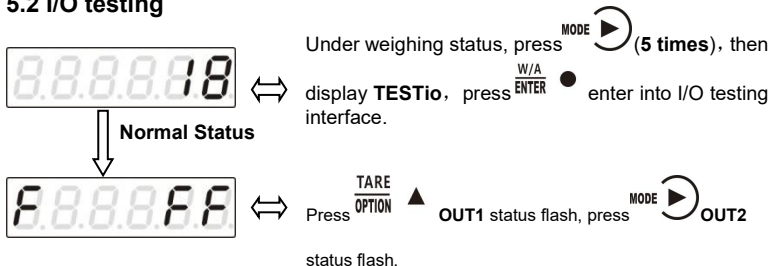



This interface shows: **IN1** input valid, **OUT1** output valid.

6 Serial Communication

GMT-P1 has RS232 or RS485 as optional to realize communication with host computer and support r-Cont、r-SP1、Modbus(bus)、tt TOLEDO、Cb920、rECont protocols and rErEAD protocol.

Serial communication terminal please refer to chapter 2.4.2、2.4.3. Baud rate and communication format setting please refer to F2.2、F2.3 and F2.4.

※Under main display (display weight value), long press $\frac{\text{TARE}}{\text{OPTION}}$ ▲ to enter into serial communication checking interface, it will display '-----' if no communication, and '-----' will flash if there's communication.

6.1 r-Cont

Indicator will send weighing data to host computer without command.

Data Format:

STX	Scale no.	Channel no.	Status	Value	CRC	CR	LF
-----	-----------	-------------	--------	-------	-----	----	----

Here:

STX — 1byte, start character **02H**

Scale no. — 2bytes, **00~99**

Status — 2bytes, high byte:**40H**; low byte definition as follows:

D6	D5	D4	D3	D2	D1	D0
Null	Null	G./N. weight	+/-	Zero point	OFL	Stable
1	0	0	0: + 1: -	0: non/zero 1: zero	0: normal 1: OFL	0: not stable 1: stable

Weight Value — 6 bytes; when weight is+ (-) overflow,return to“space space **OFL** space”

CRC — 2 bytes,check sum

CR — 1 byte, **0DH**

LF — 1 byte, **0AH**

For example:

02 30 31 31 40 41 20 20 20 37 30 30 32 34 0D 0A

Means: stable,positive data,present weight **700**

6.2 r-SP1

Code : **ASCII**

Operation code supported: **W**, write; **R**, read; **C**, calibrate; **O**, zero

6.2.1 Parameters Code Chart

Operation code	Para. code	Para. Name	number of character
R	WT	Read current status	8

		and weight	
C	ZY	Zero calibration with weight	
C	ZN	Zero calibration without weight	6
C	GY	Gain calibration with weight	6
C	GN	Gain calibration without weight	12
R	AM	Absolute millivolt	7: D6D5D4D3D2D1D0; D6:+;D5-D0: corresponding ASCII for 6 digits millivolt,Decimal point is fixed to 3 digits
R	RM	Relative zero point on millivolt	7: D6D5D4D3D2D1D0 D6 : +/-;D5-D0: corresponding ASCII for 6 digits, Decimal point is fixed to 3 digits
O	CZ	Zero clearing command	

6.2.2 Error Code Explanation

- 1: CRC check error
- 2: Operation code error
- 3: Parameters code error
- 4: Write data error
- 5: Operation invalid

6: Channel no. error

Note: Default channel no. of this indicator : **1 (31H)**

6.2.3 Command

Indicator will send weighing data to host computer after received command.

6.2.3.1 Host computer read present status

Send command:

STX	Scale no.	Channel No.	R	WT	CRC	CR	LF
------------	-----------	-------------	----------	-----------	------------	-----------	-----------

Correct response:

STX	Scale no.	Channel No.	R	WT	Status	Value	CRC	CR	LF
------------	-----------	-------------	----------	-----------	--------	-------	------------	-----------	-----------

Wrong response:

STX	Scale no.	Channel No.	R	WT	E	Error code	CRC	CR	LF
------------	-----------	-------------	----------	-----------	----------	------------	------------	-----------	-----------

Here :

STX — 1byte, start character, **02H**

R — 1 byte, **52H**

WT — 2 byte, **57H 54H**

E — 1 byte, **45H**

Status — 2bytes, high byte: **40H**; low byte definition as follows:

D6	D5	D4	D3	D2	D1	D0
-----------	-----------	-----------	-----------	-----------	-----------	-----------

Null	Null	G./N. weight	+/-	Zero point	OFL	Stable
1	0	0	0: + 1: -	0: non/zero 1: zero	0: normal 1: OFL	0: not stable 1: stable

Weight Value —— 6 bytes; when weight is+ (-) overflow,return to“space space **OFL** space”

For example:

02 30 31 31 52 57 54 40 41 30 30 33 37 35 33 33 36 0D 0A

Correct response: **02 30 31 31 52 57 54 40 41 30 30 33 37 35 33 33 36 0D 0A** (stable present value **3753**)

Wrong response: **02 30 31 31 52 57 54 45 31 31 39 0D 0A** (CRC check error)

6.2.3.2 Read other parameters

Send command:

STX	Scale no.	Channel No.	R	Para. code	CRC	CR	LF
------------	-----------	-------------	----------	-------------------	------------	-----------	-----------

Correct response:

STX	Scale no.	Channel No.	R	Para. code	Value	CRC	CR	LF
------------	-----------	-------------	----------	-------------------	-------	------------	-----------	-----------

Wrong response:

STX	Scale no.	Channel No.	R	Para. code	E	Error code	CRC	CR	LF
------------	-----------	-------------	----------	-------------------	----------	------------	------------	-----------	-----------

Para. Value —— 1byte

Para. code—2 bytes,

For example:

02 30 31 31 52 4D 52 38 39 0D 0A

Correct response: **02 30 31 31 52 4D 52 36 34 33 0D 0A** (stable range: 6)

Wrong response: **02 30 31 31 53 4D 52 45 32 30 39 0D 0A** (Operation code error)

6.2.3.3 Write max. Capacity and min. Division

Send command:

STX	Scale no.	Channel No.	W	DC	Division value	Max. capacity	CRC	CR	LF
------------	-----------	-------------	----------	-----------	----------------	---------------	------------	-----------	-----------

Correct response:

STX	Scale no.	Channel No.	W	DC	O	K	CRC	CR	LF
------------	-----------	-------------	----------	-----------	----------	----------	------------	-----------	-----------

Wrong response:

STX	Scale no.	Channel No.	W	DC	E	Error code	CRC	CR	LF
------------	-----------	-------------	----------	-----------	----------	------------	------------	-----------	-----------

Here:

DC—2 bytes, **44H 43H**

O—1 byte, **4FH**

K—1 byte, **4BH**

Division value—2 bytes, **1/2/5/10/20/50**

Max. capacity—6 bytes

For example:

02 30 31 31 57 44 43 30 35 30 31 30 30 30 36 30 0D 0A(division value **5**, Max capacity **10000**)

Correct response: **02 30 31 31 57 44 43 4F 4B 32 34 0D 0A**

Wrong response: **02 30 31 31 57 44 43 45 35 39 32 0D 0A** (Operation can't execute)

6.2.3.4 Write other parameters

Send command:

STX	Scale no.	Channel No.	W	Para. code	Para. value	CRC	CR	LF
------------	-----------	-------------	----------	-------------------	-------------	------------	-----------	-----------

Correct response:

STX	Scale no.	Channel No.	W	Para. code	O	K	CRC	CR	LF
------------	-----------	-------------	----------	-------------------	----------	----------	------------	-----------	-----------

Wrong response:

STX	Scale no.	Channel No.	W	Para. code	E	Error code	CRC	CR	LF
------------	-----------	-------------	----------	-------------------	----------	------------	------------	-----------	-----------

For example:

02 30 31 31 57 5A 52 35 30 30 38 0D 0A (Write zeroing range to **50**)

Correct response: **02 30 31 31 57 5A 52 4F 4B 36 31 0D 0A**

Wrong response: **02 30 31 31 57 5A 53 45 33 32 38 0D 0A** (Para. Code error)

6.2.3.5 Calibration Zero

1) Calibrate zero as per current weight (with weight)

Send command:

STX	Scale no.	Channel No.	C	ZY	CRC	CR	LF
------------	-----------	-------------	----------	-----------	------------	-----------	-----------

Correct response:

STX	Scale no.	Channel No.	C	ZY	O	K	CRC	CR	LF
------------	-----------	-------------	----------	-----------	----------	----------	------------	-----------	-----------

Wrong response:

STX	Scale no.	Channel No.	C	ZY	E	Error code	CRC	CR	LF
------------	-----------	-------------	----------	-----------	----------	------------	------------	-----------	-----------

Here:

Z—1 byte, **5AH**

Y—1 byte, **59H**

For example:

02 30 31 31 43 5A 59 39 34 0D 0A

Correct response:**02 30 31 31 43 5A 59 4F 4B 34 38 0D 0A**

Wrong response:**02 30 31 34 43 5A 59 45 36 32 30 0D 0A** (channel no. error)

2) Input millivolt calibration zero in the chart (without weight)

Send command:

STX	Scale no.	Channel No.	C	ZN	Zero millivolt value	CRC	CR	LF
------------	-----------	-------------	----------	-----------	----------------------	------------	-----------	-----------

Correct response:

STX	Scale no.	Channel No.	C	ZN	O	K	CRC	CR	LF
------------	-----------	-------------	----------	-----------	----------	----------	------------	-----------	-----------

Wrong response:

STX	Scale no.	Channel No.	C	ZN	E	Error code	CRC	CR	LF
------------	-----------	-------------	----------	-----------	----------	------------	------------	-----------	-----------

Here:

ZN—2 bytes, **5AH4EH**

Zero millivolt value—6 bytes

For example:

02 30 31 31 43 5A 4E 30 31 32 36 31 30 38 31 0D 0A

Correct response: **02 30 31 31 43 5A 4E 4F 4B 33 37 0D 0A**

Wrong response: **02 30 31 31 43 5A 4E 45 34 30 34 0D 0A** (Write data error)

6.2.3.6 Gain calibration

1) With weights

Send command:

STX	Scale no.	Channel No.	C	GY	Weight value	CRC	CR	LF
-----	-----------	-------------	---	----	--------------	-----	----	----

Correct response:

STX	Scale no.	Channel No.	C	GY	O	K	CRC	CR	LF
-----	-----------	-------------	---	----	---	---	-----	----	----

Wrong response:

STX	Scale no.	Channel No.	C	GY	E	Error code	CRC	CR	LF
-----	-----------	-------------	---	----	---	------------	-----	----	----

Here:

GY—2 bytes, 47H 59H

Weight value—6 bytes: Write in weight value

For example:

02 30 31 31 43 47 59 30 30 30 32 30 30 36 35 0D 0A (Write in: weight value 200)

Correct response: **02 30 31 31 43 47 59 4F 4B 32 39 0D 0A**

Wrong response: **02 30 31 35 43 47 59 45 36 30 32 0D 0A** (Channel no. error)

2) Without weights

Send command:

STX	Scale no.	Channel No.	C	GN	Gain millivolt	Weight value	CRC	CR	LF
-----	-----------	-------------	---	----	----------------	--------------	-----	----	----

Correct response:

STX	Scale no.	Channel No.	C	GN	O	K	CRC	CR	LF
-----	-----------	-------------	---	----	---	---	-----	----	----

Wrong response:

STX	Scale no.	Channel No.	C	GN	E	Error code	CRC	CR	LF
-----	-----------	-------------	---	----	---	------------	-----	----	----

Here:

Gain millivolt—**6 bytes**

Weight value—**6bytes**

For example:

02 30 31 31 43 47 4E 30 30 31 39 34 30 30 30 30 32 30 30 35 36 0D 0A (Write in: weight value **200**, corresponding gain millivolt **0.194**)

Correct response: **02 30 31 31 43 47 4E 4F 4B 31 38 0D 0A**

Wrong response: **02 30 31 31 43 48 4E 45 33 38 35 0D 0A** (Para. Code error)

6.2.3.7 Zeroing

Send command:

STX	Scale no.	Channel No.	O	CZ	CRC	CR	LF
-----	-----------	-------------	---	----	-----	----	----

Correct response:

STX	Scale no.	Channel No.	O	CZ	O	K	CRC	CR	LF
-----	-----------	-------------	---	----	---	---	-----	----	----

Wrong response:

STX	Scale no.	Channel No.	O	CZ	E	Error code	CRC	CR	LF
-----	-----------	-------------	---	----	---	------------	-----	----	----

For example:

02 30 31 31 4F 43 5A 38 34 0D 0A

Correct response: **02 30 31 31 4F 43 5A 4F 4B 33 38 0D 0A**

Wrong response: **02 30 31 31 4F 43 5A 45 35 30 36 0D 0A** (Operation can't execute)

6.2.3.8 CRC computation

All the values in front of the parity byte add together and convert to decimal data, then convert the last 2 bytes to **ASCII** code (decade in front and the unit at the back).

For example

The following is a frame of data:

0	3	3	3	4	4	5	3	3	0	0
---	---	---	---	---	---	---	---	---	---	---

Add **02~5A: 180(Hex)**, convert to decimal data: **384**. We can calculate from this that the check code is **38,34** for the data frame.

6.3 tt TOLEDO Protocol

When choose "tt" protocol in working parameter F2.3, indicator will send datas in continuous mode with TOLEDO protocol.

Continuous sending mode format as below:

1	2	3	4	5	6	7	8	9	10	11	12	13	14	15	16	17	18
---	---	---	---	---	---	---	---	---	----	----	----	----	----	----	----	----	----

STX																	0D	
------------	--	--	--	--	--	--	--	--	--	--	--	--	--	--	--	--	-----------	--

~ **A B C** display weight(6 bytes) **6pcs 30H**

Checksum

Here:start character is standard **ASII** start character **02(STX)**

status byte **A** definition as below:

D0	0	1	0	1	0
D1	1	1	0	0	1
D2	0	0	1	1	0
Decimal point	x	.x	.xx	.xxx	.xxxx

D3 D4 D6 is 0(not change) D5 is 1(not change)

status byte **B** definition as below:

D6	D5	D4	D3	D2	D1	D0
Status			Stable	Overflow	symbol	G.W.

Is 0 (not change)	Is 1 (not change)	Is 1 (not change)	1-unstable 0-stable	1-overflow 0-normal	1-negative 0-positive	Is 0 (not change)
-----------------------------	-----------------------------	-----------------------------	--------------------------------------	--------------------------------------	--	-----------------------------

status byte **C** is reserved, output 20H.

6.4 Cb920

When **F2.3=Cb920** in working parameter, indicator will send weighing data continuously without command under **Cb920** protocol.

Data format:

Status	,	G.W.	0/1	Symbol	Display	Unit	CR	LF
--------	---	------	-----	--------	---------	------	----	----

Here :

Status — 2 bytes, **OL:** (4FH 4CH) OFL; **ST:** (53H 54H)Stable; **US:** (55H 53H)unstable

, — 1 byte, separator 2CH

G.W. — 2 bytes, **GS:** gross weight 47H 53H

0/1 — 1 byte, (30H/31H) interleaved transmission

Symbol — 1 byte, 2BH (+) , 2DH (-)

Display — 7 bytes, including decimal point

Unit — 2 bytes, blank space (20H 20H)

CR — 1 byte, 0DH

LF — 1 byte, 0AH

For example: When indicator send the following automatically:

53 54 2C 47 53 31 2B 20 20 31 39 30 2E 31 20 20 0D 0A

Means: Stable、G.W.、Data value is positive、current weight is **190.1**

6.5 rECont

Indicator will send weighing data to the upper computer continuously without any command.

Return data frame format specification :

Status	,	GS	,	+/-	Display	Unit	CR	LF
2bytes	2C	47 53	2C	2B/2D	7bytes	6B 67	0D	0A

Here:

Status — 2 bytes, **OL(OFL):4FH 4CH; ST(stable):53H 54H; US(unstable):55H 53H**

Display value — 7bytes, including decimal point, high byte is blank if no decimal

point.

For example: When indicator send the following automatically:

53 54 2C 47 53 2C 2B 30 31 31 2E 31 32 30 6B 67 0D 0A

Means: Stable, Data value is positive, display value is **11.120kg**

6.6 rEREAD

Indicator will send weighing data to the upper computer under command.

Data format:

Data	R	E	A	D	CR	LF
explain	52H	45H	41H	44H	0DH	0AH

The return data frame is the same with that of **rECont** protocol, please refer to **rECont**.

- 1) Zero clearing command: ZERO ON<CR><LF> : **5A 45 52 4F 20 4F 4E 0D 0A**

Return YES<CR><LF> or NO? <CR><LF>

- 2) Calibration zeroing command: TARE ON<CR><LF> : **54 41 52 45 20 4F 4E 0D 0A**

Return YES<CR><LF> or NO? <CR><LF>

- 3) Read ID no.: GET ID<CR><LF> : **47 45 54 20 49 44 0D 0A**

Return ASCII code with 6 digits ID no.

6.7 Modbus

Indicator uses **RTU mode or ModBus-TCP mode** to communicate, every 8-byte byte of the message are divided into 2pcs of 4-byte hexadecimal characters to transmit at binary code.

Code: Binary

Function code:

Function code	Definition	Description
03	read the register	
06	preset single register	
16	preset several registers	Command only support preset double registers.
01	read coil	The length unit is byte.
05	write coil	

Exception code response

Code	Definition	Description
02	Illegal data address	Data address received from error code is not allowed
03	Illegal data value	Data wrote in is not in permissible range

04	machine fault	When indicator is trying to execute operation required, unrecoverable error is produced.
07	Unsuccessful programming request	Command received can't be executed under current condition.

6.7.1 Modbus communication address

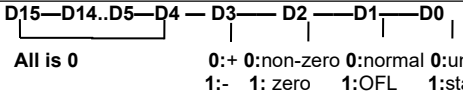
PLC addr.	Display addr.	Description
The following items are only-read register(code 0x03)		
40001	0000	Present weight value(4bytes including sign characters, the high byte is in the front)
40002	0001	
40003	0002	<div style="text-align: center;">  </div>
40004	0003	Reserve(permit to read, reading value is 0)
.....	
40006	0005	
The following items are two bytes and are available to read and write (write code 0x06, read code 0x03)		
40007	0006	Zeroing(zeroing when write in non-zero value)

40008	0007	Automatically zeroing when power on (0: OFF; 1: ON)
40009	0008	Zero tracking range (0-9d)
40010	0009	Stable range (0-9d)
40011	0010	Zeroing range (0%-99%)
40012	0011	Digit filter parameters(0-9)
40013	0012	Stability filter series(0-9)
40014	0013	AD sample rate: 0:15/s 1:30/s 2:60/s 3: 120 /s 4:480/s 5:960/s
40015	0014	Reserved
40016	0015	Communication indicating switch 0: NET indicating net weight; 1: NET indicating communication
40017~ 40018	0016~ 0017	Reserved
40019	0018	Decimal point place (0:0,1:0.0,2:0.00,3:0.000,4:0.0000)
40020	0019	Minimum division (1/ 2/ 5/ 10/ 20/ 50)
The following items are available to read and write (writing code 0x10, read code 0x03)		
40021	0020	Maximum capacity (max.capacity≤mini.division×1000000)

40022	0021	
40023	0022	Zero calibration with weights: write in 1 and calibrate zero with the current weight. Read: Absolute millivolt of current load cell
40024	0023	
40025	0024	Zero calibration without weights: Write millivolt value at zero; Write in range (load cell 3mV/V :millivolt value range within 0.02-12.000mV) millivolt value at zero when read.
40026	0025	
40027	0026	Gain calibration with weights. Write weight value(\leq max. capacity). Return millivolt at present weight value when read
40028	0027	
40029	0028	Gain calibration without weights; input gain millivolt(load cell 3mV/V:0.000 < millivolt< 15.000mV – zero millivolt).Read: millivolt value for gain calibration.
40030	0029	
40031	0030	Gain calibration weight without weights. input gain millivolt(\leq max. capacity) Read: weight value for gain calibration.
40032	0031	
40033	0032	Gross weight, with symbol.
40034	0033	
40035	0034	Net weight
40036	0035	

40037	0036	Tare weight
40038	0037	
40039~40040	0038~0039	reserved
40041	0040	Set point 1 stable or not (0: no; 1: yes)
40042	0041	Set point 1 min. duration time (0-999 : 0-99.9sec.)
40043	0042	Set point 1 valid condition
40044~40045	0043~0044	Set point 1 set value 1
40046~40047	0045~0046	Set point 1 set value2
40048	0047	Set point 2 stable or not (0: no; 1: yes)
40049	0048	Set point 2 min. duration time (0-999 : 0-99.9sec.)
40050	0049	Set point 2 valid condition
40051~40052	0050~0051	Set point 2 set value1
40053~40054	0052~0053	Set point 2 set value2
40055	0054	Set point 3 stable or not (0: no; 1: yes)
40056	0055	Set point 3 min. duration time (0-999 : 0-99.9sec.)
40057	0056	Set point 3 valid condition
40058~40059	0057~0058	Set point 3 set value 1
40060~40061	0059~0060	Set point 3 set value 2

40062	0061	Set point 4 stable or not (0: no; 1: yes)	
40063	0062	Set point 4 min. duration time (0-999 : 0-99.9sec.)	
40064	0063	Set point 4 valid condition	
40065~40066	0064~0065	Set point 4 set value 1	
40067~40068	0066~0067	Set point 4 set value 2	
40069	0068	Output 1 user-defined	
40070	0069	Output 2 user-defined	
40071	0070	Input 1 user-defined	
40072	0071	I/O output value	Note: available only when coil address 00016 is valid. Input write 1 valid, 0 invalid. Read 1 valid, 0 invalid
40073	0072	I/O input value	
40074	0073	Ethernet communication mode	0: b tcp; 1: Cont
Reserved			
40399	0398	Current weight value(4 bytes floating-point number , high digit in front)	
40400	0399		
40401	0400	Current weight value(4 bytes with symbolic number, high digit in front)	
40402	0401		

40403	0402	D15—D14……D4 0 D3 0:+ 1:- D2 0:non-zero 1:zero D1 0:normal 1:OFL D0 0:Stable 1:Unstable	
40404	0403	0	
40405	0404	6 digits without symbolic number, user ID no.	
40406	0405		
The following items are byte read only. (read code: 0x03)			
49001	9000	Version no.	If display10024, formatXX XXXX,main version no., hardware no., software no..So main version no.01, hardware no. 00, software no. 24
49002	9001		
49003	9002	Develop time	If display 141024, means 24 th Oct., 2014
49004	9003		
The following items are byte read only. (read code: 0 x 0 1)			
00001	0000	0: unstable; 1: stable	
00002	0001	0: normal; 1: OFL	

00003	0002	0: non-zero; 1: zero
00004	0003	0: +; 1: -
00005	0004	Reserved
00006	0005	Reserved
The following item are available to read and write (read code: 0x01, writing code: 0x05)		
00007	0006	Automatically zeroing when power on (0: OFF; 1: ON)
00008	0007	Reserved
00009	0008	Reserved
00010	0009	Reset all
00011	0010	Reset calibration
00012	0011	Reset parameters
00013	0012	Reset I/O
00014	0013	Reserved
00015	0014	Reserved
00016	0015	I/O testing switch
00017	0016	Set point 1 status
00018	0017	Set point 2 status
00019	0018	Set point 3 status
		Only read: 0:invalid, 1:valid

00020	0019	Set point 4 status	
00021	0020	Reserved	
00022	0021		
00023	0022	Tare (Write ON to proceed)	
00024	0023	Add tare (Write ON to proceed)	
00025	0024	Net weight (0: Gross weight, 1: Net weight)	
00026~ 00032	0025~ 0031	Reserved	

7 Ethernet communication

GMT-P1 digital indicator can connect with RJ-45 cable to communicate with host computer or PLC by Ethernet port.

User need set IP address in F3 working parameters. For example, if IP is 192.168.101.106, then input 192 at F3.1, input 168 at F3.2, input 101 at F3.3, input 106 at F3.4; input port no. at F3.5





After cable connected, orange light is bright for good communication and green light is sparkle in communication. The DATA light will sparkle in Modbus/TCP communication and will be off if the communication is broken.

8 Password Input and Setting Reset

8.1 Password Input

- (1) Indicator calibration and working parameters setting default password: **000000**.
- (2) User can set password in parameters when **F4.1** is "ON".
- (3) When display is "PASS", need to input correct password to enter parameters.

Note:

- (1) When input password, if first time wrong, it will go to the second chance for password input (display from  turn to ).
- (2) If second input wrong, it will enter into interface for inputting password the third time
(Display change from  to ).
- (3) If Input wrong for three times, main display show "Error4" and self-lock, but user can operate when power on again.

8.2 Password Setting

- (1) User can set password in parameters when **F4.1** is "ON".

- (2) User must input same new password twice in setting password, If not same, main display show "**Error**" one second and return to **PASS** again.

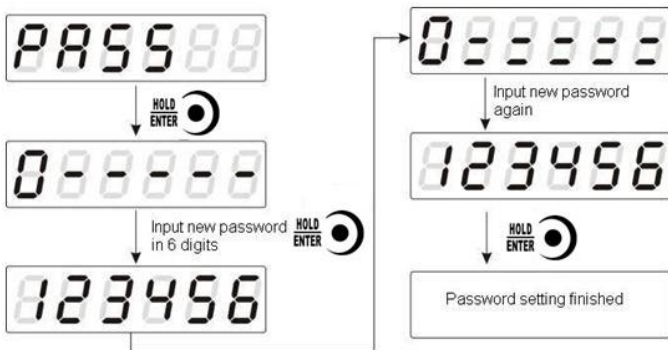

8.3 Factory Reset

Note: Factory reset is only for special technicians, which will reset all of parameters and will maybe cause not working.

Take reset all for example:

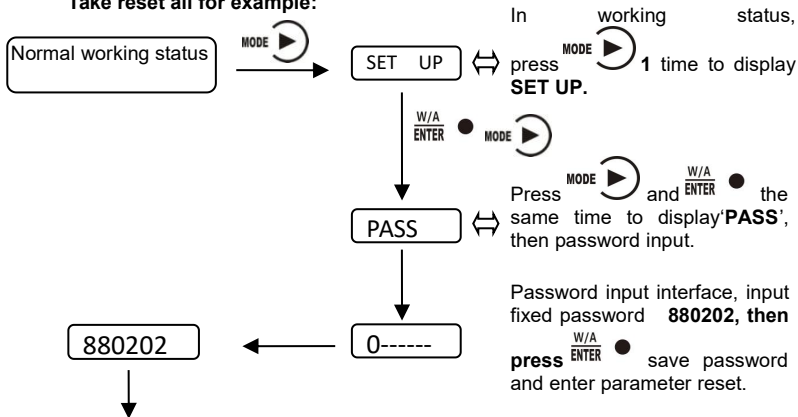

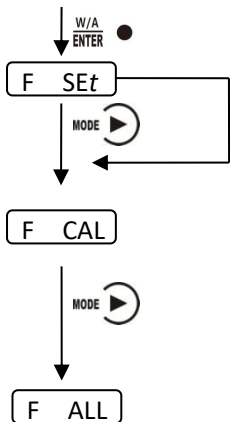

⇔ 1) In **F SET** interface, press **W/A ENTER** to reset working parameters, enter into reset calibration parameters interface.

2) In **F SET** interface, press **MODE**, not to make working parameter reset, enter into calibration para. Reset interface.

⇔ 1) In **F CAL** interface, press **W/A ENTER** to reset calibration para., enter into reset all interface.

2) In **F CAL** interface, press **MODE**, not to make calibration para. reset, enter into reset all interface.

⇔ 1) In **F ALL** interface, press **W/A ENTER** to make reset all of the parameters (including working para., calibration para., I/O etc..)

Note: In all reset interfaces, press **ZERO ESC** to exit and return to weighing interface.

9 Display Testing

The following flow chart is to test lights on main-display and status lights.

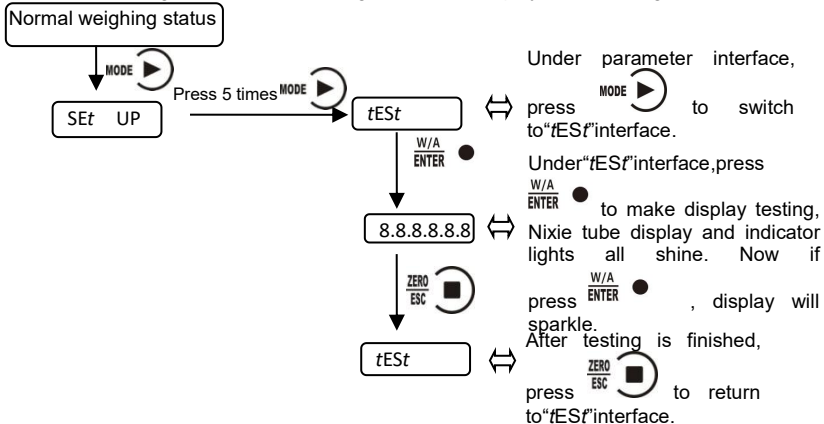

10 Errors and Alarm Messages

Error ① Input error.

② wrong data beyond parameter range.

Error 2 The present weight value is out of zeroing range.

Error 3 Scale platform is not stable when zeroing.

Error 4 Input wrong password more than 3 times.

Error 5 Overlimit when tare.

Error 6 Weight value is not stable when tare.

OFL Weighing value is positive overflow.

-OFL Weighing value is negative overflow.

11. Indicator model user-defined function

Long press MODE to display "LOGO" and enter the setting interface. Press ZERO to return to the setting menu

After saving, the next boot will show the newly edited model number.(ModbusTCP does not add a write function.)Add files such as "LogoSetupThread. C "and" logosetuthread. H ".

Displays character comparison table

a	b	c	d	e	f	g	h	i	j	k	l	m
A	b	C	d	E	F	G	H	,	J	K	L	m
n	o	p	q	r	s	t	u	v	w	x	y	z
n	o	P	q	r	S	t	U	v	w	x	y	z

12 Dimension of Indicator

Dimension of rear panel: **92×45(mm)**

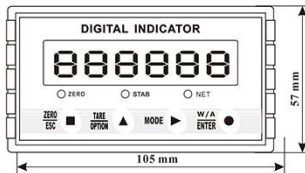
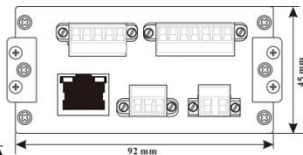

Dimension of front panel: **105×57(mm)**

Panel cutout dimension: **93×46(mm)**

