

GMT-X1

User's Manual

110611020002
VER01.00.01_01

Copyright © Shenzhen General Measure Technology Co., Ltd. All Rights Reserved.
Without the permission of Shenzhen General Measure Technology Co., Ltd. no unit or individual shall copy, transmit, transcribe or translate into other languages in any form or by any means.



Warning

The transmitter uses DC24V power supply, use AC220V power will cause permanent damage to the transmitter.

Please keep the transmitter well grounded.

The transmitter is electrostatic sensitive equipment, please pay attention to take anti-static measures in the use and maintenance

Standard &
Certification

Product Standard: GB/T 7724—2008

Verification Regulation: JJG 669-2016

CMC Accuracy Class 3 (6000e)

Safety Certificate: CE

Content

1. General Description.....	- 1 -
1.1 Functions and Characteristics.....	- 1 -
1.2 Technical Specifications.....	- 1 -
2 Panels and buttons.....	- 3 -
2.1 Front Panel Description.....	- 3 -
2.2 Key specification.....	- 3 -
3 Installation and Wiring.....	- 5 -
3.1 Connection of Power Supply.....	- 5 -
3.2 Connection of Load Cell.....	- 5 -
3.3 Connection of I/O Terminal.....	- 6 -
3.4 Connection of Analog.....	- 7 -
3.5 Serial Port Output.....	- 7 -
3.5.1 Serial port fault troubleshooting.....	- 8 -
3.6 NetCom Connection.....	- 8 -
3.6.1 NetCom fault troubleshooting.....	- 8 -
4 Menu Review.....	- 9 -
4.1 Parameter option and setting.....	- 10 -
5. Basic parameter.....	- 11 -
5.1 Content.....	- 11 -
5.2 Zero Cfg.....	- 12 -
5.3 Tare function.....	- 12 -
6 Weight Format.....	- 14 -
6.1 Weight Format.....	- 14 -
6.2 CAL Zero.....	- 15 -
6.3 CAL Weight.....	- 16 -
6.4 Theory CAL.....	- 17 -
7 Application.....	- 18 -
7.1 Input Cfg.....	- 18 -
7.2 Output Cfg.....	- 19 -
7.3 Application.....	- 19 -
7.4 Application Example.....	- 20 -
8 Data-Trans.....	- 22 -
8.1 Serial port parameters.....	- 23 -
8.2 NetCOM parameters.....	- 23 -
8.3 Analogue Parameters.....	- 23 -
8.4 Print Edit.....	- 24 -
9 Maintenance.....	- 25 -
9.1 IO Test.....	- 25 -
9.2 Serial Port Test.....	- 26 -
9.3 Analog CAL.....	- 26 -
10 Communication protocol and address.....	- 28 -
10.1 Modbus protocol.....	- 28 -
10.1.1 Function code and and exception code description.....	- 28 -
10.1.2 Communication Mode.....	- 28 -
10.1.3 Modbus communication data sheet.....	- 29 -
10.2 Continuous send A (CB920)	- 42 -
10.3 Cont-B (Continuous send -tt)	- 42 -
10.4 r-Cont.....	- 43 -
10.5 rE-Cont.....	- 44 -
10.6 YH Protocol.....	- 44 -

10.7 PROFINET Protocol	- 44 -
10.7.1 IO state	- 45 -
10.7.2 Device description file GSD	- 49 -
10.8 EtherNet-IP Protocol	- 49 -
10.8.1 IO state	- 49 -
10.8.2 Device description file EDS.....	- 53 -
11. DIMENSION.....	- 54 -

1. General Description

1.1 Functions and Characteristics

Shell type	DIN Rail mounted, stainless steel housing	
load cell interface	1 way 6 wire analog load cell weighing platform interface, connection only 8 350 Ω load cells at most	
Display	128*32 0.91" white light OLED	
Language	Support Chinese, English	
Preset point function	8 - way comparator 11 comparison options	
Interface	1 way RS232/RS485 interface	
	1 way RS485 interface	
	Support 5.0 blue tooth module connect with smartphone App	
	Option 1	3 in 5 out Transistor I/O interface
		3 in 4 out Relay output interface
	Option 2	1 way 485+1 DA output
		2 in 4 out Transistor I/O interface
	Option 3	Double network port, built-in switch
		Profinet Bus interface
		Ethernet/IP Bus interface

1.2 Technical Specifications

Power supply	24VDC (12~30VDC)
Dimension	131*111.4*32 (mm)
GW	500g
Certified working environment	-10 ~ 40 °C ; 90% R.H without dew
Working environment	-20 ~ 60 °C ; 90% R.H without dew
Storage environment	-40 ~ 60 °C ; 90% R.H without dew
Power	5W
Weighing platform excitation voltage	5V 200mA (MAX)
Weighing platform requirements	A simulated weighing platform interface, connection only 8 350 Ω load cells, most support 1 mv/V, 2 mv/V, 3 mv/V sensitivity
Input impedance	0.1uV/d/0.5uV/d
Non-linearity	0.01% F.S
A/D conversion speed	50; 60; 100; 120; 200; 240; 400; 480; 800; 960 (SPS)

Display Precision	1/999999
Keyboard	6 key sound keyboard
Decimal Places	0、0.0、0.00、0.000、0.0000; 5 options
Overload	Weight over range

2 Panels and buttons

2.1 Front Panel Description

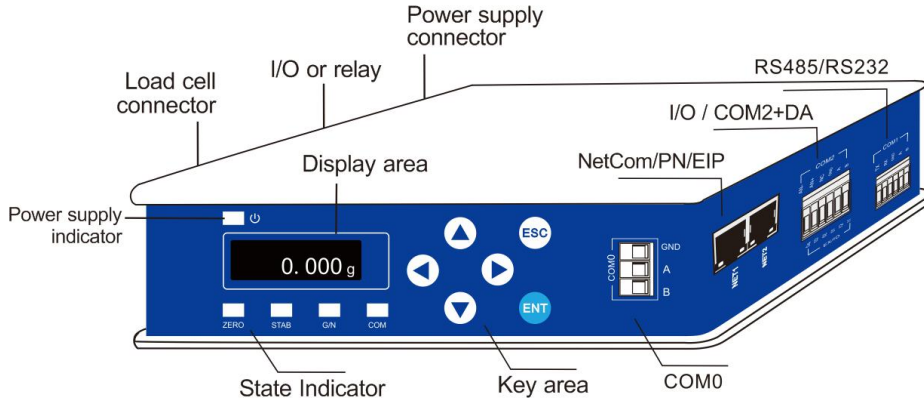







Status :

- : power, lights up when indicator is power on
- **ZERO**: Light on when material weight is $0 \pm 1/4d$.
- **STAB**: Light on when material weight is within stable range.
- **G/N**: Gross weight/Net weight, indicator flashes when the current display is new weight.
- **COM**: Light on when in communication status.
Item 576x (system information item) defines which port status the COM indicator light indicates.

2.2 Key sepcification

GMT-X1 has 6 button functions, short press and long press have differences, button diagram is shown as below:

Key	Interface	Short press	Long press
	Weight Display page	Switch displayed information: Weight/Flowrate/Analog output	Switch displayed information: Weight/Loadcell Input
	Menu interface	Previous SubParameter	/
	Data input	Data +1	Switch Capital
	Weight Display page	Tare(If Gross)/Clear Tare(If Net)	Gross/Net weight display switch
	Menu interface	Next SubParameter	/

	Digital input	Data -1	Clear number data to 0
	Menu interface	Next SubParameter	/
	Weight Display page	Check Tare value(If Gross)	Shortcut to preset tare value(If Gross)
	Menu interface	Next SubParameter	/
	Data input	Input position move to left	/
	Option select	/	/
	Weight Display page	Print	Print empty line
	Menu interface	Right Parameter Menu	/
	Data input	Input position move to right	/
	Option select	/	/
	Weight Display page	Menu page	Software Version review
	Menu page	Comfirm Selection	/
	Data input	Comfirm Selection	/
	Option select	Comfirm Selection	/
	Weight Display page	Zero(If Gross), N/A(if Net)	Fast Calibrate Zero(If Gross), N/A(if Net)
	Menu page	Return to previous level	/
	Data input	Exit Page	/
	Option select	Back to Weight Display page	/

3 Installation and Wiring

3.1 Connection of Power Supply

GMT-X1 weighing transmitter connects with DC24V power supply as follows.

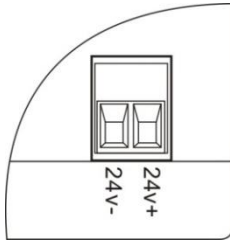

NOTE: The transmitter uses DC24V power supply, use AC220V power will cause permanent damage to the transmitter.

3.2 Connection of Load Cell

GMT-X1 weighing transmitter connects with bridge type resistance strain gauge load cells.

PORTS	EX+	SN+	EX-	SN-	SIG+	SIG-	SHL
6 wires	EX+	SN+	EX-	SN-	SIG+	SIG-	SHL
4 wires	EX+		EX-		SIG+	SIG-	SHL

※ When connected to a 4-wire load cell, the EX+ and SN+ ports, EX- and SN- ports must be short-connected. Otherwise, the transmitter weight data reading is not normal.

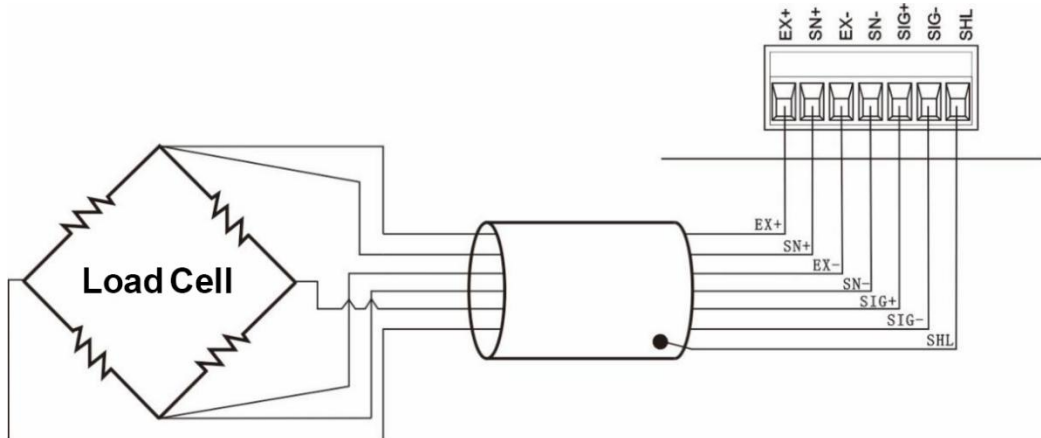

NOTE:

1. As the output signal of the load cell is an analog signal sensitive to electronic noise, shielded cables should be used for load cell wiring and laid separately from other cables, especially away from ac power supply
2. For the occasions with short transmission distance and little temperature change or low accuracy requirements, four-wire load cell can be selected. However, for applications requiring high transmission distance or accuracy, a six-wire load cell should be selected.

3. For the application of multi-load cell parallel connection, the sensitivity (mV/V) of each load cell should be consistent.

3.3 Connection of I/O Terminal

GMT-X1 weighing transmitter I/O module is an optional interface function. Two interfaces are optional. Option 1: 3 IN 5 OUT (or can choose 3 IN 4 OUT relay output connector) : Option 2: 2 IN 4 OUT

Standard IO is transistor collector open output mode with each drive current of 200mA

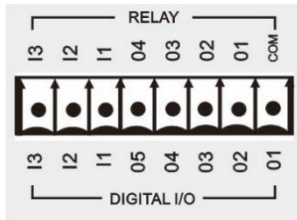

Option 1

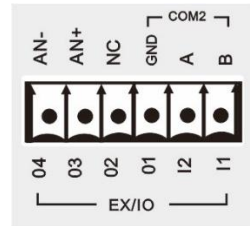

Option 2

The factory default low level of input and output interfaces is valid. The user can set this in [Input Cfg] [output Cfg] parameter

The input port unified level mode, that is, the IN1 mode is set as high level, then IN2 and IN3 are set as high level simultaneously and are effective. The output port can be set to high and low level mode separately

Transmitter input interface schematic diagram (low level mode):

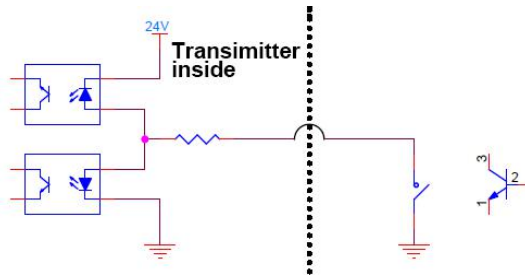

Schematic diagram of transmitter output interface (high level mode) :

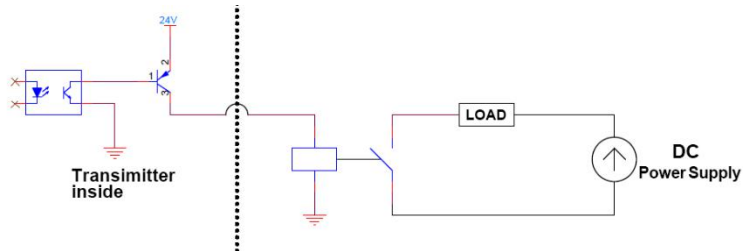

The default definition is as follows:

Output		Input	
OUT1	N/A	IN1	Zero
OUT2	N/A	IN2	Tare
OUT3	N/A	IN3	Clear Tare

OUT4	N/A		
OUT5	N/A		

3.4 Connection of Analog

GMT-X1 have analog output function, 1 channel analog output function is optional. Interface AN+ (positive), AN- (negative).

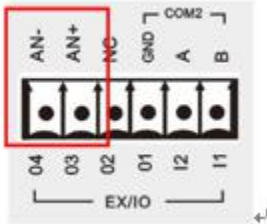

Analog output can be divided into two types: voltage output and current output. User can select the corresponding mode in the output mode

Please refer to analog mode and calibration

[8.3 analogue parameter](#)

3.5 Serial Port Output

GMT-X1 weighing transmitter Possesses : RS485 , RS232/485. Extensible optional 1-way RS485 (Order Declaration)

COM0: Standard serial port

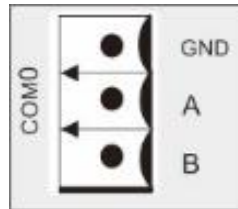

COM1: Standard serial port, **RS232/RS485** (Parameter 427x selection)

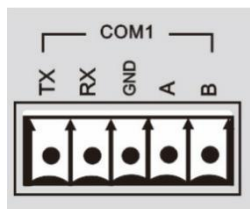

COM2: Serial port optional

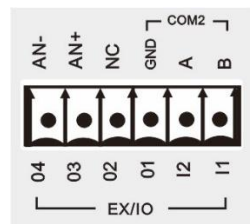

RS232 connection mode:

RS485 connection mode:

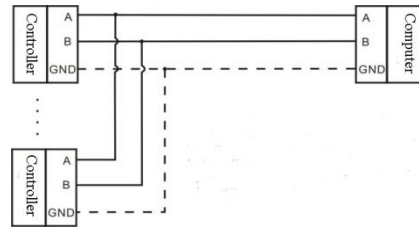
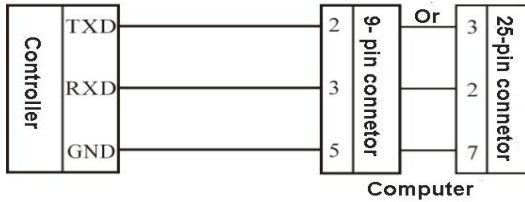

※ GND is ground of RS485, it can very much improve communication quality via connecting with GND by low-resistance wire when there is a lot of disturbance in working field.

※ GND must be connected in RS232 mode

3.5.1 Serial port fault troubleshooting

If serial port can't communicate, please check:

- Refer 1.1 to check line, make sure connection is correct.

RS232 must connect 3 lines, **Rx**、**Tx**、**GND**.

RS485 must connect line **A**、**B**.

- Make sure connecting port parameters are the same to computer.

COM ID、 baud rate、 data format and communication protocol must consistent with the computer and PLC.

3.6 NetCom Connection

GMT-X1 support NetCom communication and **PN/EIP** bus communication mode (optional fuction, make statement when order) .Support **TCP** protocol (**Modbus/TCP**, **Cont-A/TCP**, **Cont-B/TCP**, **r-Cont/TCP**, **rE-Cont/TCP**, **YH/TCP**) and **EIP/PN** bus protocol.

NetCom optional, NetCom has built in switch, converient cascade.

3.6.1 NetCom fault troubleshooting

If NetCom can't communicate, please check:

- Check NetCom indicator light
Hardware connect normal, light is on.
Cable connect normal, light is flash.
- Check communication protocol is consistent with computer and PLC.

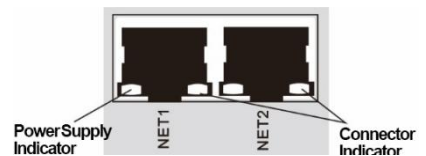

- Make sure **GMT-X1** can be **PING** by the network. If not, check the hardware interface section.
- Confirm if there are IP conflicts.
- Restart

4 Menu Review

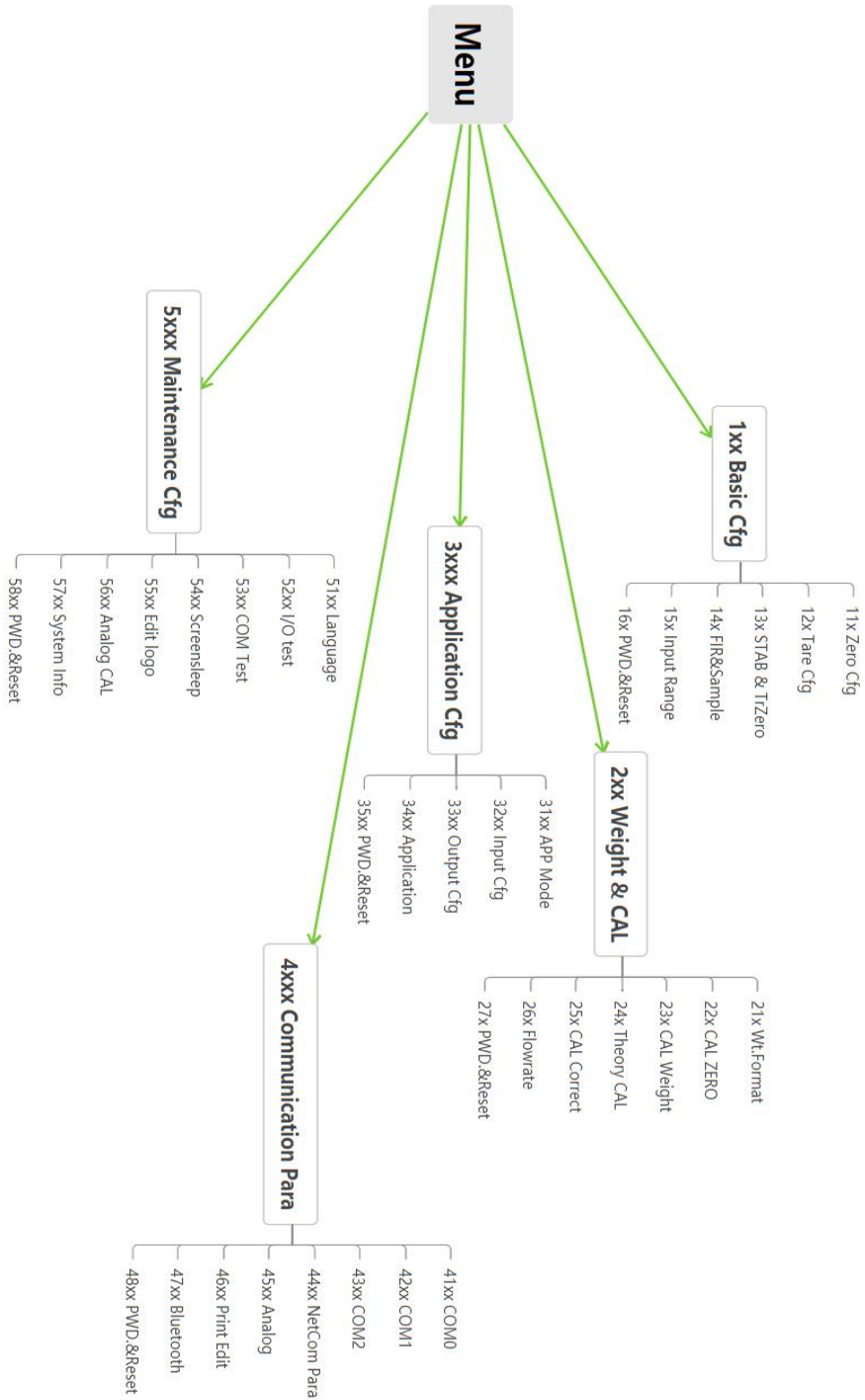

4.1 Parameter option and setting

Parameter option: (Select tare operation switch parameter)

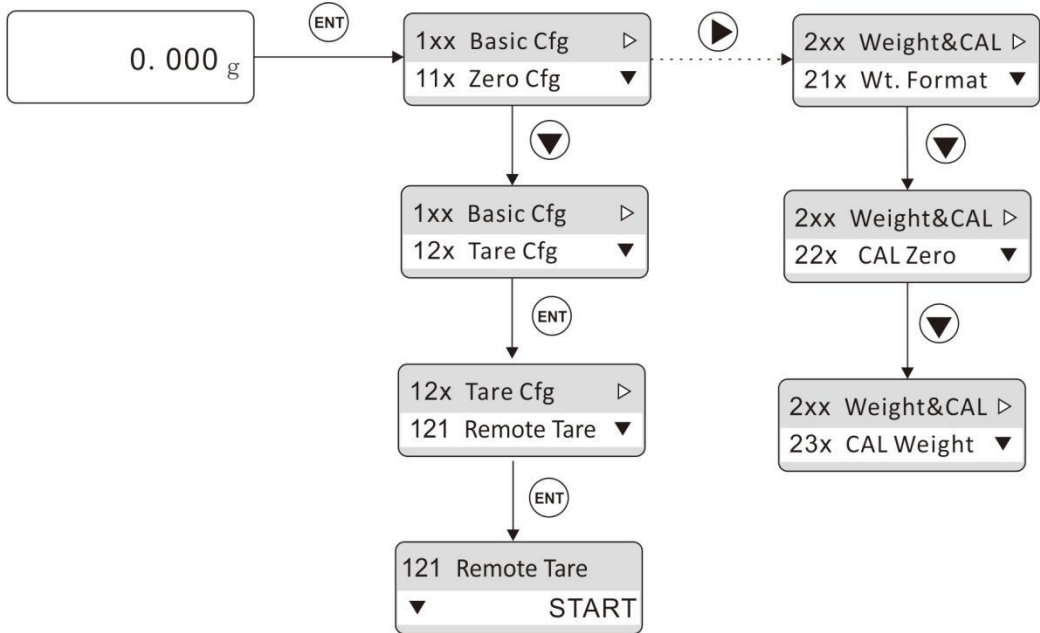

Parameter Setting: (Set the power reset range from 49% to 30%)

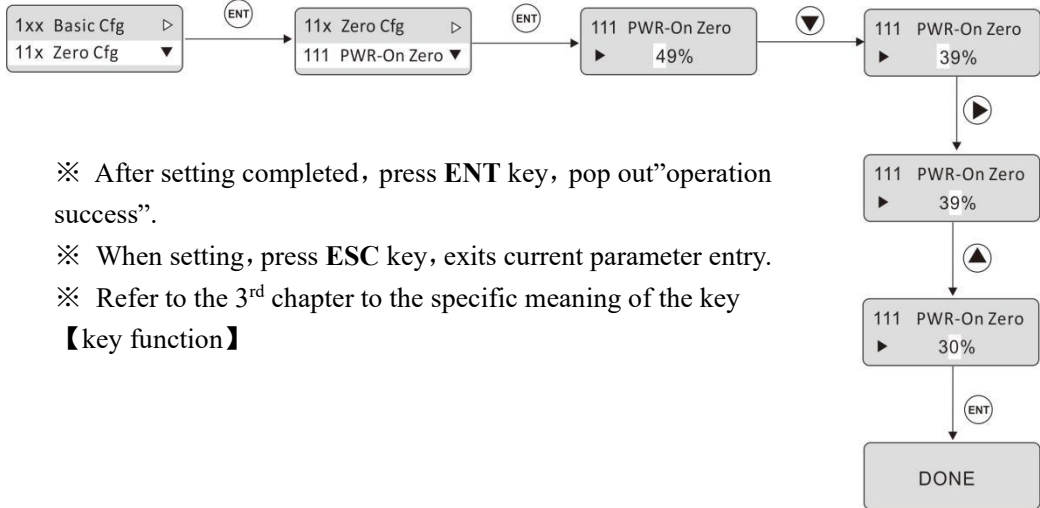

※ After setting completed, press **ENT** key, pop out”operation success”.

※ When setting, press **ESC** key, exits current parameter entry.

※ Refer to the 3rd chapter to the specific meaning of the key

【key function】

5. Basic parameter

5.1 Content

Parameter	Default Value	Description
11x Zero Cfg		
111 PWR-On Zero	20	Range: 0~99 (× full range%); When set to 0 , turn off PWR-On Zero, otherwise, reset the initial according to the reset range.
112 Remote Zero	On	After enabling, the zeroing operation can be carried out through the communication port. If set to close, the communication port can not be reset.
113 Zero Range	20%	Range: 1~99 (× full range %)
12x Tare Cfg		
121 Remote Tare	On	Range: On; Off
122 Tare Record	Off	Range: On; Off
123 NetSign COR	Off	Range: On; Off
124 Preset Tare	0	Range: 0 ~range
13x STAB&TrZero		
131 STAB Range	1	Range: 0-99 , When the parameter is 0, turn off the STAB function and the weight STAB marker is always in effect. When the parameter is not 0, the weight is stable if the weight variation range is not greater than the set fractional read during the stability determination time
132 STAB Timer	1000ms	Range: 1-5000 Milliseconds. If the weight range does not exceed the STAB range during that time, the weight is stable
133 TrZero Range	1d	Range 0-9d . Turn off the zero tracking function when the parameter is 0. When the parameter is not zero, the weight change is less than the range of zero tracking time, the system will automatically track zero.
134 TrZero Time	1000ms	Range 1-5000ms , during the tracking time, if the weight change is less than the tracking range, the system will automatically track the zero position

14x FIR&Sample		
141 Digit-Filter	4	Range: 0-9 ; The larger the number is, the higher the filtering intensity will be, but the response time will be longer.
142 Adv. Filter	00	Range 0-99d , At 0, the steady-state filter is turned off. When the parameter is non-zero, if the weight change is within the range, then the steady-state filter is started
143 AD Sample Rate	200	Range: 50; 60; 100; 120; 200; 240; 400; 480; 800; 960 (SPS) 。
15x Input Range		
151 Input Range	0-10mV (unipolarity 2mV/V load cell)	Range: 0-5mV; 0-10mV; 0-15mV, -5-5mV; -10-10mV; -15-15mV adjusts the signal acquisition range according to the input range to ensure the measurement is more accurate
16x PWD.&Reset		
161 Reset Basic	//	Restore factory setting operation for basic parameters
162 Remote Edit	ON	After enabling, the basic parameters can be set through the communication port. Otherwise, the communication port is read-only to the basic parameters.
163 PWD. Protect	OFF	Setting range: ON; OFF
164 PWD. Edit	000000	

5.2 Zero Cfg

Zero success condition:

- 1) Weighing platform stable; 2) Weight is in zero range.

Zero Cfg:

- 1) Press Zero; 2) Zero input port is valid; 3) communicate port zero (Remote Zero is ON)

5.3 Tare function

Tare operation ON/OFF:

ON/OFF serial port with **IO** tare; This set to ON for tare setting operation.

Tare Record:

ON/FORBIT Tare Record function. If turn ON, power off restart, retain tare weight.

NetSign COR:

OFF: NetSign have no operation.

Correct Tare: When transmitter in net weight status, the net weight is negative and weight is stable, then indicator will correct tare value to ensure Net weight is not negative.

Automatic Tare clean: When transmitter in net weight status, the net weight is negative and weight is stable, then indicator will back to gross weight status

Preset Tare:

Set tare weight, if the value is not 0, then this tare weight is used for tare.

※NOTE: ① The transmitter is in tare state, when clear tare, transmitter record GW, enter NW mode.

② The transmitter can't be reset in the mode of NW display.

6 Weight Format

When **GMX-T1** weight transmitter or any part of the weighing system is changed for the first time and the current equipment calibration parameters can't meet the user's requirements, the display shall be calibrated. Calibration can determine the system zero and gain of the weighing system.

6.1 Weight Format

Parameter	Initial Value	Decription
21x Weight Format		
211 Unit	kg	Range: t; kg; g; lb
212 Decimal	0	Range: 0; 0.0; 0.00; 0.000; 0.0000
213 Division	1	Range: d=1, d=2, d=5, d=10, d=20, d=50, d=100, d=200, d=500, default: d=1
214 Full Scale	100000	The full range value of the transmitter is generally taken from the load cell range, and when it exceeds the range (exceeding the "range +9 Division "), prompt message is given, so as not to damage the load cell by weighing over pressure
22x CAL Zero		
221 Auto Capture		After emptying the scale, press the "OK" button and set the current state to zero
222 Key In mV		Manually and manually input the voltage of 4 decimal points as the zero point voltage
23x CAL Weight		
231 Weight CP1		Calibrate weight points, support 5-point calibration.
232 Weight CP2		When the front point is calibrated, the other weight points will be reset to the uncalibrated state (the default value is 10.0000mV, 10000kg).
233 Weight CP3		
234 Weight CP4		
235 Weight CP5		If the marking point 1 is performed, the marking point 2-5 is reset to 0
24x Theory CAL		
241 LC mV/V	2.0000	True load cell sensitivity, 4 decimal points, average sensitivity if multiple load cells
242 LC Capacity	100000	The true load cell range, if there are more than one load cell, is the sum of all load cell ranges
243 Use T-CAL	OFF	Enable calibration of theoretical values and make them effective
25x CAL Correct		

Correct Coef		After calibration, if the zero point is correct, the weight has deviation, which can be used to correct the weight value. The value calculation: if the transmitter weight is A, but the weight after weighing is B, the correction coefficient is calculated: (actual weight × current correction coefficient)/B shows A weight
26x Flowrate		
261 SampleWindow	1.000s	Range : 0.500-60.000s . Define the length of sample window for flowrate calculation.
262 Max Flowrate	10. 000	Range 0-999999 , Define the max flowrate value. For analog output indication.
263 FlowrateUint	/ hour	Range: 0-/hour, 1-/minute, Define Flowrate display unit.
27x PWD.&Reset		
271 Cal Reset	//	Restore factory setting operation for calibration parameters (hardware protection switch must be off)
272 Remote Cal	OFF	After enabling, the calibration parameters can be set through the communication port. Otherwise, the communication port is read-only to the basic parameters.
273 HWD. Protect	OFF	Calibration is not allowed until the hardware protection dial code is enabled in the ON position
274 PWD. Protect	OFF	After enabling to enter the change parameter setting option requires password, password is required when switching.
275 PWD. Edit	000000	

6.2 CAL Zero

Zero calibration is the zero calibration of the scale.

Zero calibration can be done in two ways: automatic acquisition and manual input. The “Auto Capture “method must be used for zero calibration when new equipment or weighing structure is adjusted

Auto Capture:

Calibration conditions: stable scale

Transmitter displays current millivolt. After empty the scale, press **ENT** to calibrate the current state to zero.

Load cell voltage
0. 6688mV

Key In mV:

User need key in voltage value of ZERO point to calibrate ZERO

222 Key In mV
00. 0000mV

※ Generally used for no-weight calibration, the value recorded by the data recorded during the calibration of the weights is used for Key In mV.

6.3 CAL Weight

Cal weight is to use standard weights for weight calibration.

Supports 5-point calibration, providing users with the maximum ability to select calibration points according to their needs.

Calibration method:

※ Zero calibration should be completed before weight calibration

23x CAL Weight
231 Weight CP1

Press ENT

➤ **0. 0000mV**
➤ **000000**

- 1) Load weights onto the weighing table
- 2) Enter the weight value corresponding to the weight

➤ **0. 1000mV**
➤ **001000**

Multi-point calibration attention:

- 1) User can choose the number of marking points, such as single point calibration, which can be withdrawn after the first weight point is calibrated
- 2) Cross-point calibration is not allowed. For example, when using 3-point calibration, it is necessary to calibrate the Weight CP1, 2 and 3, but it is not possible to calibrate the Weight CP3 and 4 by crossing the Weight CP2 after the completion of the Weight CP1
- 3) In the multi-point calibration, the weight should be increased. For example, the weight of Weight CP2 must be heavier than the weight of Weight CP1

6.4 Theory CAL

Calibration of theory value means that weight calibration is performed by inputting load cell sensitivity and load cell range value

Theory CAL takes 3 steps:

- 1) Set load cell sensitivity (If multiple load cell are connected, input the mean value)
- 2) Set total range of the load cell (If connected to more than one load cell, input total range)
- 3) Turn on "Use T-CAL" key.

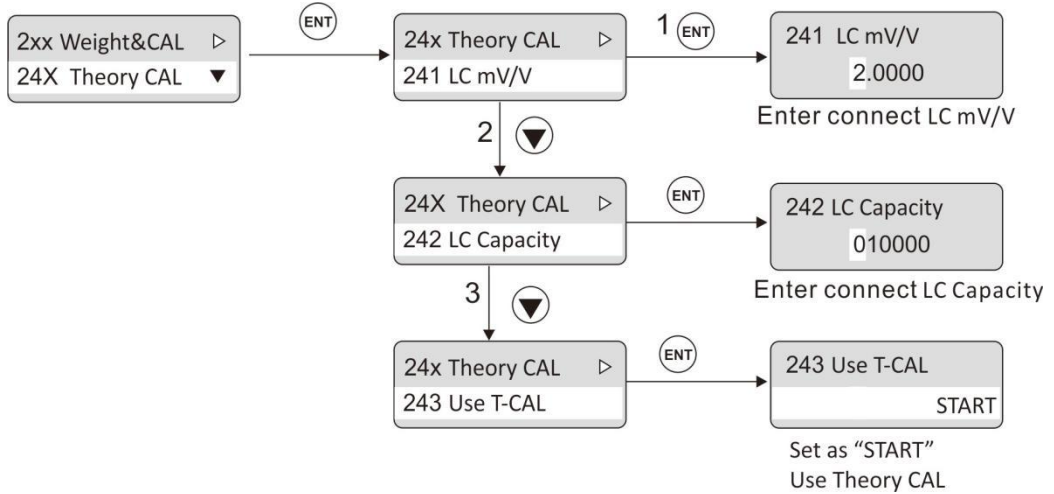

7 Application

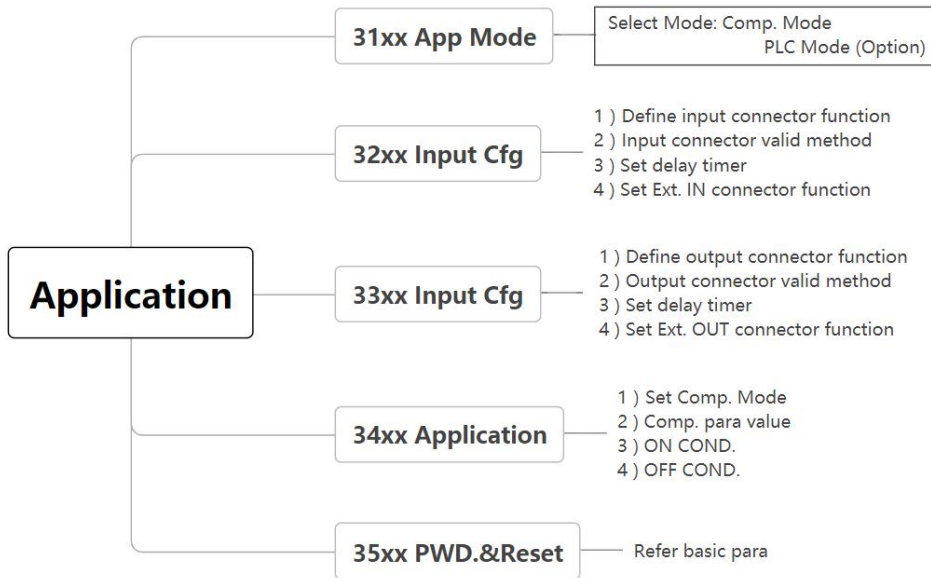

7.1 Input Cfg

The output port configuration parameter is in item 32xx of the transmitter. The transmitter is standard equipped with 3 input and 5 output, and can be extended with 2 input and 4 output, which can satisfy the function of 5 in and 9 out IO.

Each input port can set the application function, mode (high and low level is effective), debounce time.

※ In PLC mode, only valid mode of high and low level is set, and the debounce time is 5mS by default.

Parameter	Parameter Item	Specification
32xx Inport (1-3Extend Port)	IN X Function	NONE, ZERO, CAL-ZERO, TARE, CLEAR-TARE, GROSS/NET, COMP-ON, PRINT, P_EMPTY_LINE ※ It is defined as nonfunctional that is, the input port is nonfunctional
	IN X Mode	Range: Low_Level, High_Level. Default: Low_Level. Define which type input signal to detect.
	IN X Delay	Avoid misjudgment caused by signal jitter. Initial Value: 5ms ; Range: 0-200ms

※ When select the IO add-on board in the special interface, the extension input 1 and input 2 will be available. The function, mode and debounce of the extension port are the same as the normal input port

Example: Define Input2 as TARE

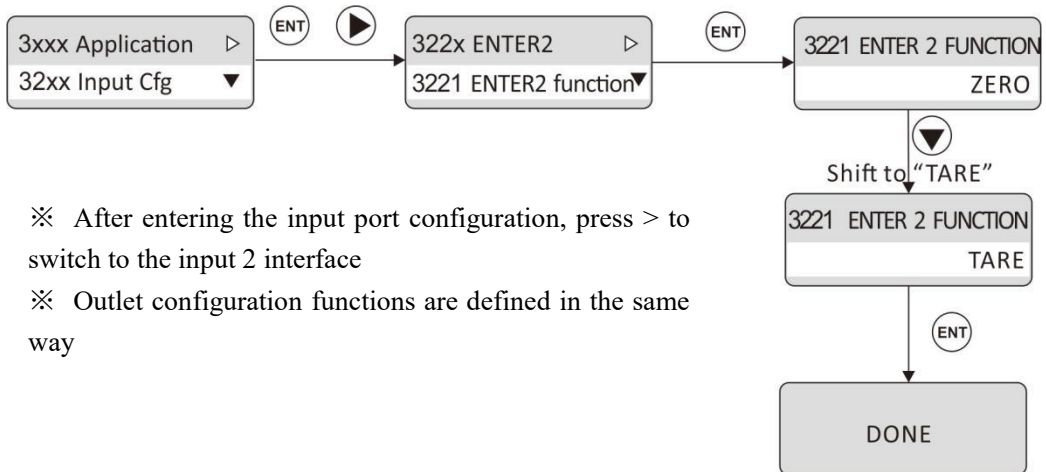

- ※ After entering the input port configuration, press > to switch to the input 2 interface
- ※ Outlet configuration functions are defined in the same way

7.2 Output Cfg

Output Cfg is in item 33xx of the transmitter. Each output can set the application function and mode separately (high and low level is effective). No initial output by default. Must be defined by the customer

Output application function

Application function	Implication
NONE	No-output
COMP 1-8	COMP 1-8 When achieve, has output.
STAB	When STAB is valid, has output
Zero	Valid when Zero indicator light has output
NW	When is NW, output is valid
PRINT	When printing, output is valid
-SIGN	When weight is less than 0, output is valid
COM-Pulse	Except PN protocol, 1Hz square wave is emitted during communication

※ When the Extended IO Add-on Board is selected, the Extended Outlet 1-4 function selection is available. The function and mode of the Extended Outlet is the same as that of the ordinary Outlet

※ PLC mode output port no functional definition optional, only set the output level mode.

7.3 Application

Application parameters are configured in item 34xx of the transmitter. In the application parameters, set the Comp. Mode, comparison conditions, effective time and failure time parameter values.

GMT-X1 has 8 Comp. Mode function, **341x—348x**

Parameter	Specification
Comp. Mode	Weight/flow judgment: \leq , =, \neq , \geq , $<>$, \nlessgtr
CompValue 1	The first priority is higher, and the default comparison value is taken when there is only one comparison parameter. Initial value: 0; Range: -999999-999999
CompValue 2	Used when two comparison values are needed. The value must be greater than the initial value of the first comparison value: 0; Range: -999999-999999
ON COND.	When the comparison is successful, the meter outputs additional constraints in effect. 1, immediate output (as long as the comparison conditions are established immediately output), 2, stable output (when the comparison conditions are established and the current weight is stable output), 3, delay mode (the success time exceeds the decision time output). Initial value: output immediately
TRUE JudgeT	The minimum decision time for success
OFF COND.	The extra requirement for indicator to deactivate output when comparator equation is FALSE. Three options: Immediately, Stable, Delay Immediately: output immediately OFF, if equation is FALSE; Stable: output OFF, if equation is FALSE and weight is stable; Delay: output OFF, if equation is FALSE and and keep FALSE status longer than FALSE HoldT time ; In Programmer Mode, this parameter can not be seen.
FALSE HoldT	Range 0-50000ms, default: 1000, If OFF COND. Is Delay mode, the comparator equation has to be FALSE and keep FALSE status longer than FALSE HoldT time to force indicator deactivate output signal if not Delay mode, this parameter can not be seen.. In Programmer Mode, this parameter can not be seen.

7.4 Application Example

Example 1: When the weight is greater than or equal to 500g, the output 1 is valid; when the weight is not satisfied and the weight is stable, the output 1 is invalid.

Setup: 1) Outlet 1 is set to: Comparator 1

- 2) The comparison mode is set to \geq
- 3) The comparison value 1 is set to: 500.
- 4) The comparison value 2 is set to 0 (single point comparison, this parameter is invalid).
- 5) The realization mode is set as: output after the weight stabilizes
- 6) The decision time is: 0 (in non-delay mode, this parameter is invalid)
- 7) Failure mode is set to: Invalid after weight stabilization
- 8) Failure determination time: 0 (in non-delay mode, this parameter is invalid)

※If the weight is greater than or equal to 500g, the steady state remains invalid, then output 1 does not switch to the valid state.

Example 2: The weight is not between 200g and 500g, and the output 4 is effective after 5mS delay; if the condition is not met, the output 4 is invalid after 5mS delay.

Setup: 1) Outlet 4 is set to: Comparator 1

2) Compare mode is set to: Not between.

3) The comparison value 1 is set to: 200.

4) The comparison value 2 is set to 500 (this value should be greater than 4.3.1.2).

5) The realization mode is set as: Delay output

6) The time to reach the decision is: **5mS**.

7) The failure mode is set to delay output.

8) The failure determination time is: **5mS**.

8 Data-Trans

GMT-X1 has various communication function interfaces: 1 channel RS485 (serial port 0), 1 channel RS232/485 (serial port 1), 1 channel RS485 optional port (serial port 2), 1 channel DA optional interface, 1 network port communication interface (support TCP, PN/EIP bus functions).

※ For communication protocol and address, please refer to 《 GMT-X1 Communication Manual》 .

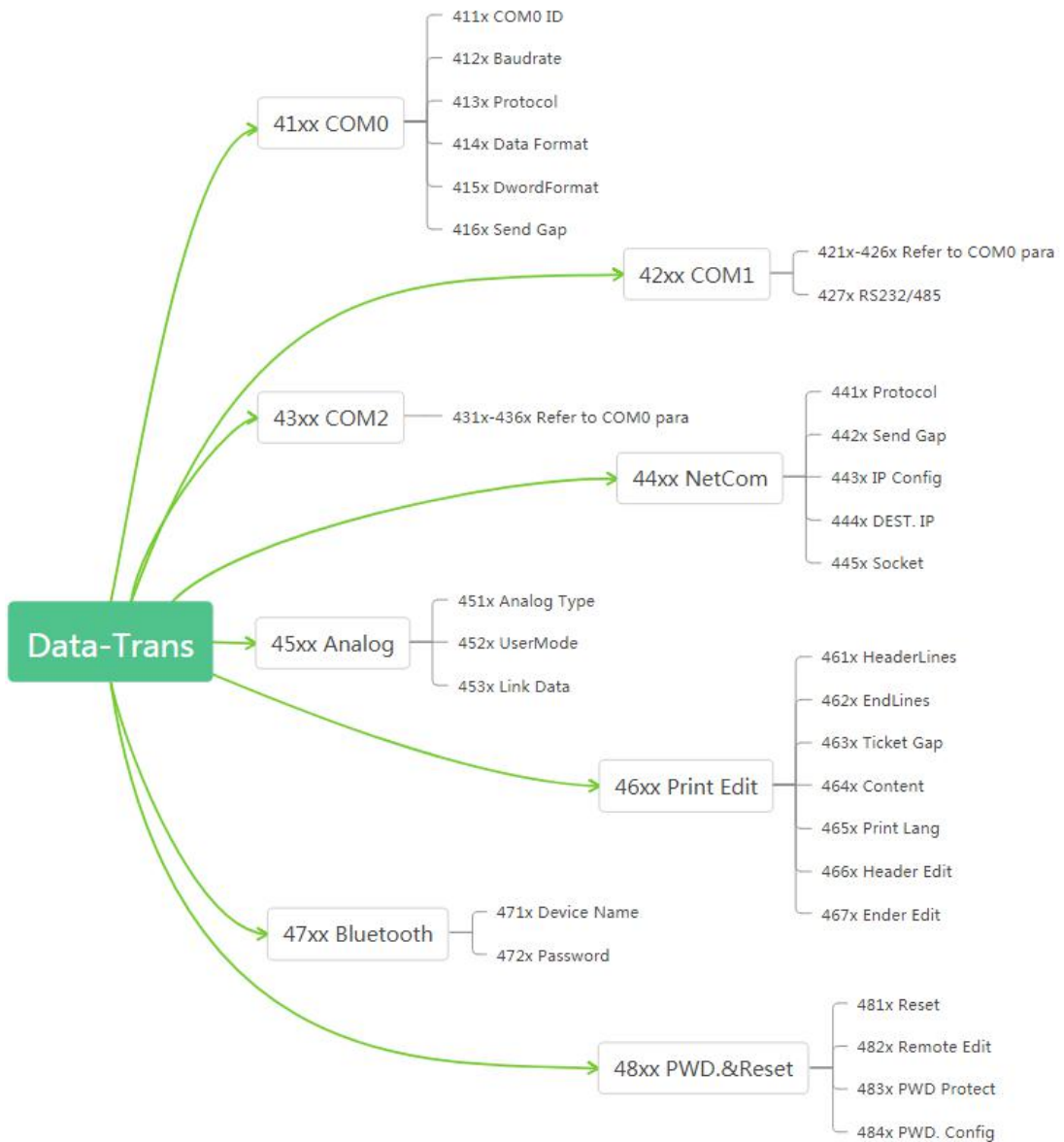

8.1 Serial port parameters

Serial port parameters	Initial Value	Specification
411x COM0 ID	01	Range: 01-99
412x Baudrate	38400	Range: 1200, 2400, 4800, 9600, 19200, 38400, 57600, 115200
413x Protocol	Modbus RTU	Range: ModbusRTU, ModbusAscii, Continuous sendA (CB920), Continuous send B(tt), r-Cont, rE-Cont, YH Protocol, printing
414x DataFormat	8-E-1	Range: 8-N-1, 8-E-1, 8-O-1, 7-N-1, 7-E-1, 7-O-1
415x DwordFormat	AB-CD	Range: AB-CD (Hi word) 、 CD-AB (Lo word)
416x Send Gap	20ms	Under continuous transmission protocol, the time interval between frames. Range 0-1000ms, Default: 20ms
427x RS485/RS232	485	Range: 485 mode, 232 mode is optional. ※ Parameter only available under serial port 1

8.2 NetCOM parameters

NetCOM parameters	Initial Value	Specification
441x Protocol	Cont-A/TCP	When selecting a normal network port, the protocol has : Modbus/TCP, Cont-A/TCP, Cont-B/TCP, r-Cont/TCP, rE-Cont/TCP, YH/TCP, default Modbus/TCP
442x Send Gap	1000ms	When you select UDP mode to send, the parameters are visible and used to control the time interval between frames. The range of 0-1000 ms Parameters are not visible when other protocols are selected
443x IP Config	192.168.0.100	This parameter is not visible if there is no additional board for the NetCOM port.
444x DEST. IP	192.168.0.101	The IP of the destination address is visible only when using the UDP-type protocol, otherwise it is not
445x Socket	502	Range: 0-65535

8.3 Analogue Parameters

Analogue Parameters	Initial Value	Specification
451x Analog Type	4-20mA	Range: 4-20mA; 0-10V; User power, user voltage

452x UserMode	4521 Min. Out	0	The parameter is valid in user power and user voltage modes.
	4522 Zero Out	0	
	4523 F.S. Out	0	
	4524 Max. Out	0	
453x Link Data		Weight	Range: Weight,flow, GW, NW Analog corresponds to weight form

8.4 Print Edit

Print Parameters	Initial Value	Specification	
461x HeaderLines	1	Range 0-4	
462x EndLines	1	Range 0-4	
463x Ticket Gap	2	Range 0-99	
464x Content	Display Weight	Optional: display weight, gross weight, net weight, flow rate, net weight + tare (two lines), gross weight + flow rate, full information (gross weight + net weight + tare) (print includes units)	
465x Print Lang	English	Chinese, English	
466x Header Edit	4661 HeaderLine 1	-----	HeaderLine, Can edit 16 English characters
	4662 HeaderLine 2	-----	
	4663 HeaderLine 3	-----	
	4664 HeaderLine 4	-----	
467x Ender Edit	4671 EnderLine 1	-----	EnderLine, Can edit 16 English characters
	4672 EnderLine 2	-----	
	4673 EnderLine 3	-----	
	4674 EnderLine 4	-----	

Example:

Parameters Setting		Print Content (English)
HeaderLine	2	-----
EnderLine	1	-----TEST-----
Ticket Gap	3	No. XXXXXXX1
Content	Display weight	Display weight
Print Lang	English	NT -X.XXXX kg
HeaderLine1	-----	-----END1-----
HeaderLine 2	-----TEST-----	
EnderLine 1	-----END1-----	
		----- (Print 2rd)

9 Maintenance

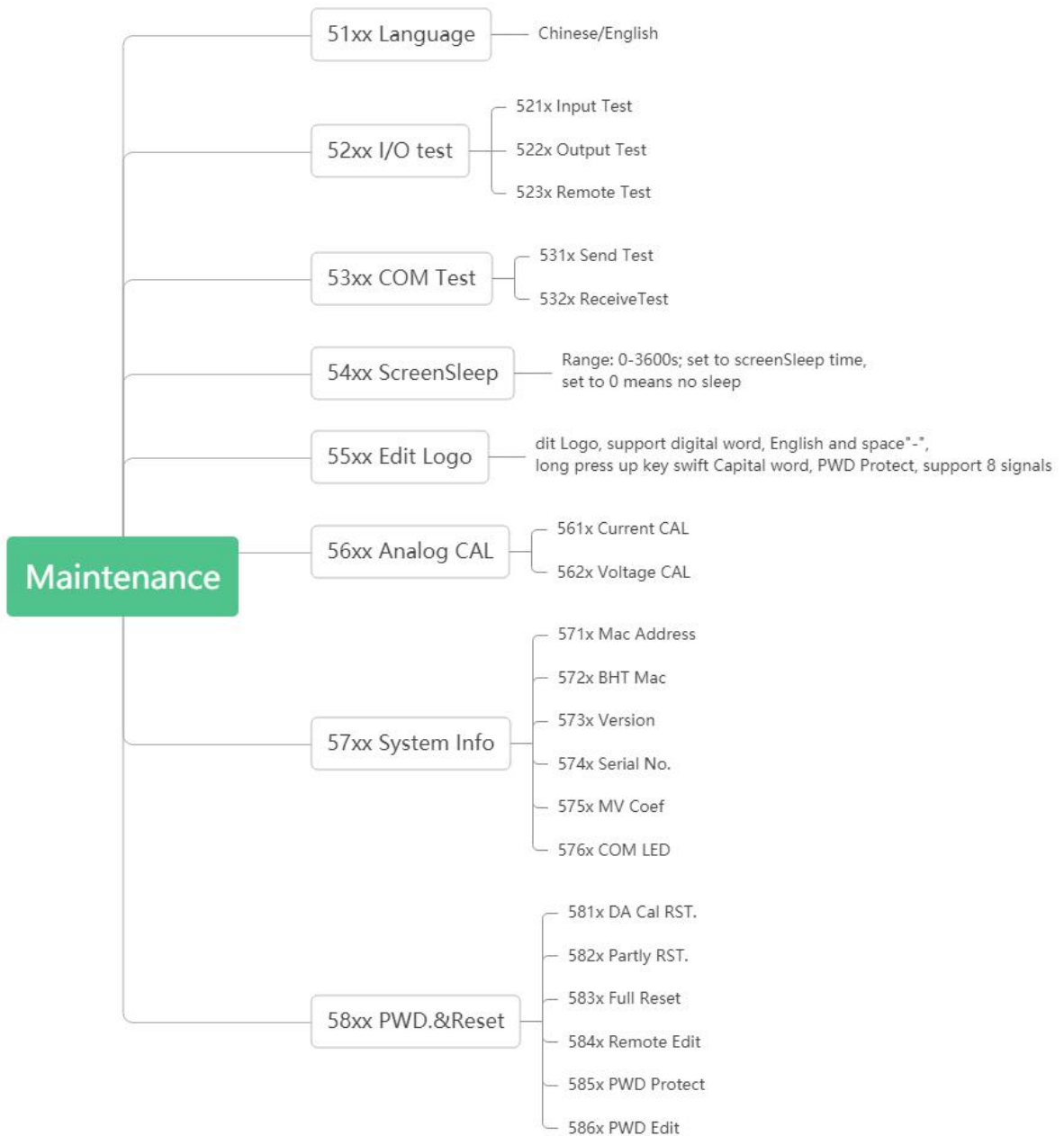

9.1 IO Test

IO The test function is used to test whether the connection state of the input/output outlet is normal.

Input Test:

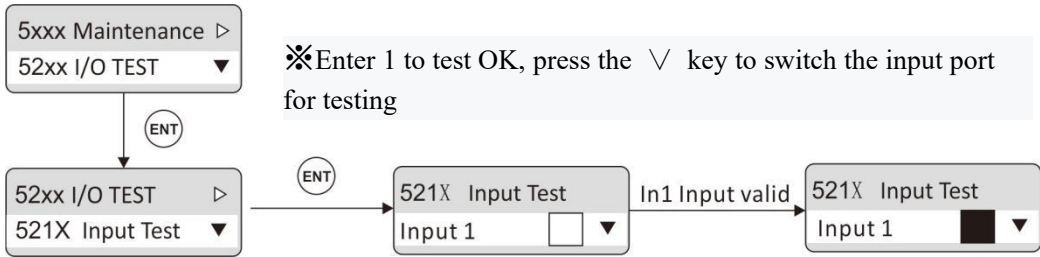

※ Enter 1 to test OK, press the \checkmark key to switch the input port for testing

Output Test:

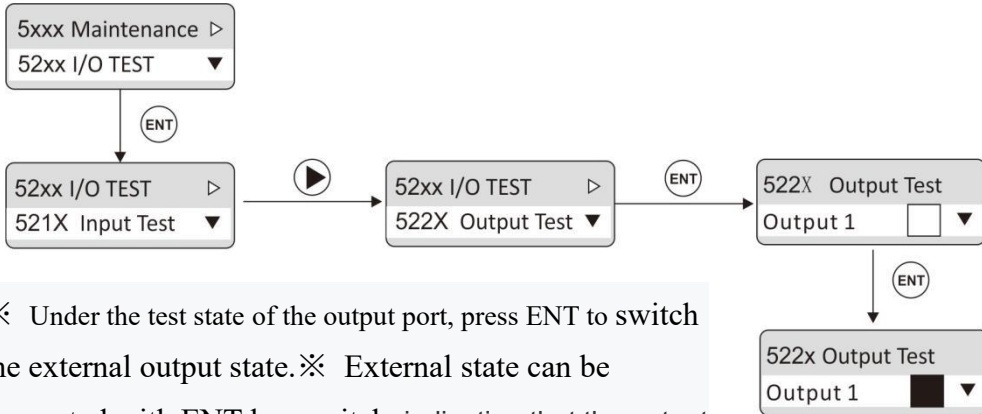

※ Under the test state of the output port, press ENT to switch the external output state. ※ External state can be converted with ENT key switch, indicating that the output port is normally connected.

Output 1 valid means output connector state is ok

9.2 Serial Port Test

Serial port test function, in a fixed baud rate (9600), data format (8-N-1) to send and receive data, to detect the serial port connection status.

Send Test: send data "COMX TEST NNN". If it is serial port 1, then X=1, if there is an additional board serial port test, then X=2.

Receive test: the external sends test data (ASCII code only) to the meter and displays the data on the display. The data length of each frame cannot exceed 10 bytes.

If the external sends 30 31 41 to the meter and the meter displays as shown in the figure below, then the COM0 connection is normal.

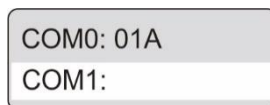

9.3 Analog CAL

If the transmitter is equipped with the analog expansion board, the analog output function is provided. The output mode can be selected from the parameter list (see Section

8.3).Under normal display state, press \wedge key to view analog output.The format is: X.XXXMA /V.

The transmitter has been calibrated on the analog output when it leaves the factory. The user does not need to calibrate the analog output.If the analog output of the transmitter is abnormal, the user can calibrate the analog output by himself.The calibration method is as follows - take the current calibration as an example

(it is recommended to conduct calibration under the guidance of a professional) :

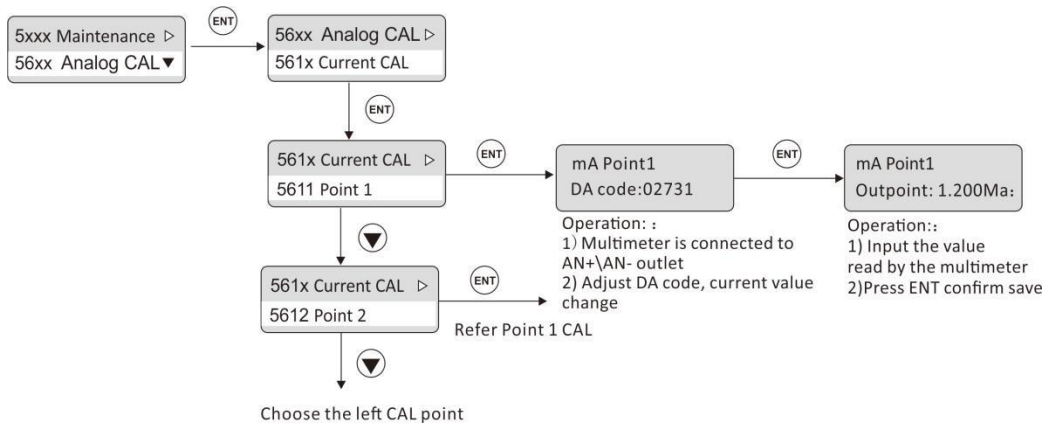

- 1) Switch to 56XX "Analog Calibration" under the parameter of 5XXX [System Maintenance]
- 2) Switch to 561x "Current Calibration"
- 3) Select "Point 1", press ENT to enter the DA code input interface, and the multimeter is connected to the analog output interface.Adjust the DA code, and the analog value changes with the DA code
- 4) When the value of the multimeter is adjusted to the desired current value, press ENT to enter the interface of current output value. Input the value of the multimeter at this time.
- 5) Current calibration supports 5-point calibration.The customer adjusts the calibration according to his needs

10 Communication protocol and address

10.1 Modbus protocol

10.1.1 Function code and exception code description

Function code

Function code	Item	Specification
03	Read register	
06	Write a single register	
16	Write multiple registers	This transmitter command only supports writing to the double register. When writing, the address must be aligned. It is not allowed to write only part of the double register.
01	Read the coil	Note that this length is in bits.
05	Write the coil	

Note: Only supports above Modbus function codes. When sending other function codes the transmitter will not respond.

Exception Code Respond

Code	Item	Specification
02	Illegal data address	This error code indicates that the data address received is not allowed.
03	Illegal data value	The data written is not in the allowed range.
04	Computer	An unrecoverable error occurred while the transmitter was attempting to perform the requested operation.
07	Unsuccessful programming request	For the transmitter, the command received cannot be executed under the current conditions.

10.1.2 Communication Mode

RTU

- (1) When communicating in RTU mode, every 8 bits (1 byte) in the data is divided into two 4-bit hexadecimal characters
- (2) The end of a frame should be marked with an interval of more than 3.5 characters. Recommended for a more reliable finish.

The specific protocol is as follows:

Supported data format: 8-bit data bit, 1-bit stop bit, parity check (8-E-1)

8 data bits, 1 stop bit, odd check (8-O-1)

8 data bits, 1 stop bit, no checksum (8-n-1)

8 data bits, 2 stop bits, no checksum (8-n-2)

Baud Rate: **9600、19200、38400、57600** (optional)

Code: Binary

ASCII

When communicating in ASCII mode, every 8 bits (1 byte) in a message is transmitted as two ASCII characters

The specific agreement of this mode is as follows:

Supported data format: 7 data bits, 1 stop bit, parity check (7-E-1)

7 data bits, 1 stop bit, odd check (7-O-1)

7 data bits, 2 stop bits, no check (7-N-2)

Baud Rate: **9600、19200、38400、57600、** (optional)

Code: ASCII code

10.1.3 Modbus communication data sheet

PLC Address	Display Address	Specification	Specification		
40001-40002	0000-0001	Current weight value(4-byte signed integer number)			
40003-40004	0002-0003	Reserved			
40005	0004	Current state	byte	Specification	
			.13—15	Reserved	※ Indicates the weight status. When it is the current state, the status bit displays "1". If the current weight is zero and stable, then the address D0D1 status bit is "1"
			.12	bipolar	
			.11	Weight is calculated using theoretical values	
			.10	ADC breakdown	
			.9	Current display NW	
			.8	Million volts stable	
			.7	Load cell -overflow	
			.6	Load cell +overflow	
			.5	Weight -overflow	
			.4	Weight +overflow	
			.3	Overflow state	
			.2	display weight -	
.1	Zero				
.0	stable				
40006	0005	Error code 1	.13-15	Reserved	
			.12	Remote calibration is performed when remote calibration is prohibited	

			.11	The calibration is in hardware protection
			.10	The previous weight point is not calibrated
			.9	Beyond minimum resolution
			.8	Weight input exceeds the maximum range
			.7	Weight input can't be 0
			.6	Weight calibration less than zero or the previous standard point
			.5	Load cell overflow is positive during weight calibration
			.4	Load cell overflow is negative during weight calibration
			.3	The weight calibration is not stable
			.2	load cell overflow is positive during zero calibration
			.1	load cell overflow is negative during zero calibration
			.0	The zero calibration is not stable
40007	0006	Error code 2	.10-15	Reserved
			.9	The remote tare operation permit switch is not enabled when the tare is operated remotely
			.8	Net weight status does not allow tare
			.7	Net weight status does not allow zeroing
			.6	The remote reset switch is not turned on during remote reset
			.5	The load cell is overflowing when zero is cleared
			.4	Negative load cell overflow during zero clearance
			.3	Zero clearance is unstable
			.2	Clear out of range
			.1	Unstable when reset on power
.0	Power on clear zero out of range			
40008-40010	0007-0009	Reserved		
40011	0010	Process status flag bits	.13-15	Reserved
			.12	Power calibration
			.11	Voltage calibration

			.10	IO testing
			.9	Printing. (valid when performing printing operations)
			.8	COMP 8 ON
			.7	COMP 7 ON
			.6	COMP 6 ON
			.5	COMP 5 ON
			.4	COMP 4 ON
			.3	COMP 3 ON
			.2	COMP 2 ON
			.1	COMP 1 ON
40012-40018	0011-0017	Reserved		
40019-40020	0018-0019	GW value(4-byte signed integer number)		
40021-40022	0020-0021	NW value(4-byte signed integer number)		
40023-40024	0022-0023	Tare weight value(4-byte signed integer number)		
40025-40026	0024-0025	Flow value(4-byte signed integer number)		
40027-40028	0026-0027	Display weight value (floating-point type)		
40029-40030	0028-0029	GW value (4-byte signed floating point number)		
40031-40032	0030-0031	NW value (4-byte signed floating point number)		
40033-40034	0032-0033	Tare weight value (4-byte signed floating point number)		
40035-40036	0034-0035	Flow value (4-byte signed floating point number)		
40037-40038	0036-0037	AD code after filtering		
40039-40040	0038-0039	Load cell volt		
40041-40042	0040-0041	Relative zero voltage value		
40043~40091	0042~0090	Reserved		
40092	0091	Input state area	Byte	Specification
			.5	Reserved
			.4	Enter 5 state (extended input 2)
			.3	Enter 4 state (extended input 1)
			.2	Enter 3 state
			.1	Enter 2 state
.0	Enter 1 state			
40093	0092	Reserved		
40094	0093	Output state area	Byte	Specification
			.9-15	Reserved
			.8	Output state 9 (extended output 4)

			.7	Output state 8 (extended output 3)
			.6	Output state 7 (extended output 2)
			.5	Output state 6 (extended output 1)
			.4	Output state 5
			.3	Output state 4
			.2	Output state 3
			.1	Output state 2
			.0	Output state 1
40095~40100	0094~0099		Reserved	
Basic parameter area, remote setting parameter 162 set to open to read and write, otherwise read only				
40101-40102	0100-0101	PWR-On Zero	0%-99% of the maximum range, default: 0 (off)	
40103-40104	0102-0103	Remote Zero ON/OFF	Range: 0 (off), 1 (on); Default: 1 (enabled)	
40105-40106	0104-0105	Zero range	1%-99% of the maximum range, default: 20%	
40107-40108	0106-0107	Remote Tare	Range: 0 (off), 1 (on); Default: 1 (ON)	
40109-40110	0108-0109	Tare Record	Range: 0 (off), 1 (on); Default: 1 (OFF)	
40111-40112	0110-0111	NetSign COR	Range: 0 (off), 1 (correction), 2 (return gross weight); Default: 0 (off)	
40113-40114	0112-0113	Preset tare	Range: 0~ full scale. Initial values: 0	
40115-40116	0114-0115	STAB Range	Range: 0-99d , default 1	
40117-40118	0116-0117	STAB Timer	Range: 1-5000 ms, default 1000	
40119-40120	0118-0119	TrZero Range	Range: 0-99d , default 1	
40121-40122	0120-0121	TrZero Time	Range: 1-5000 ms, default 1000	
40123-40124	0122-0123	Digit-Filter	Range: 0-9 , default 4	
40125-40126	0124-0125	Adv. Filter	Range: 0-99d , default 0	
40127-40128	0126-0127	AD Sample Rate	Range: 0-9 (corresponding 0-50; 1-60; 2-100; 3-120; 4-200; 5-240; 6-400; 7-480; 8-800; 9-960) default 4: 200Hz	
40129-40130	0128-0129	Input Range	Range: 0-5 (corresponding 0: 0-5mV; 1: 0-10mV; 2: 0-15mV; 3: -5-5mV; 4: -10-10mV; 5: -15-15mV) default: 1 (0-10mV)	
40131~40200	0130~0199	Reserved		
40201-40202	0200-0201	Unit	Range: 0-3; 0-t, 1-kg, 2-g, 3-lb	
40203-40204	0202-0203	Decimal	Range: 0-4; 0-0, 1-0.0, 2-0.00, 3-0.000, 4-0.0000	
40205-40206	0204-0205	Division	Range: 1, 2, 5, 10, 20, 50, 100, 200, 500	
40207-40208	0206-0207	Full Scale	Range: 0- Division *200000	
40209-40210	0208-0209	Reserved		
40211-40212	0210-0211	Auto zero cal	Only write 1 ; write 1 , Performs zero calibration of	

			the current state. Fix four decimal places
40213-40214	0212-0213	Manual zero cal	Range: 0-150000 ; write ms
40215-40216	0214-0215	Weight CP1	Write the weight value to the calibration weight point 1 calibration
40217-40218	0216-0217	Weight CP2	Write the weight value to the calibration weight point 2 calibration
40219-40220	0218-0219	Weight CP3	Write the weight value to the calibration weight point 3 calibration
40221-40222	0220-0221	Weight CP4	Write the weight value to the calibration weight point 4 calibration
40223-40224	0222-0223	Weight CP5	Write the weight value to the calibration weight point 5 calibration
40225-40226	0224-0225	LC mV/V	Write the actual sensitivity of the load cell for the theoretical value calibration
40227-40228	0226-0227	LC Capacity	Write the total range of the load cell for theoretical calibration
40229-40230	0228-0229	Use T-CAL	Write 1 to enable theoretical value calibration, write 0 to use calibration data
40231-40232	0230-0231	Correct Coef	Write the coefficient to modify the calibration, write the data integer type, the system default data write data with 5 decimal point
40233-40234	0232-0233	Flow SampleWindow	Range: 1000-60000 。 Write 10000 equivalent to setting to 10.000s
40235-40236	0234-0235	Max Flowrate	Range: 0-999999. Sets the maximum amount of flow
40237-40238	0236-0237	FlowrateUint	Range: 0-1 ; 0 : /h, 1 : /m
40239~40300	0238~0299	Reserved	
Apply parameter area, address range 4x00301-4x08000.The remote setting (352X) is read-write when enabled, otherwise read-only			
40301-40302	0300-0301	Select Mode	Comp. Mode; PLC programming mode
40303-40304	0302-0303	Input1 function	Comp. Mode: parameter range 0-7 , 0 -no function、 1 -zero、 2 - Cal-Zero、 3 -tare、 4 -clear tare、 5 -GROSS/NET、 6 - COMP-ON、 7 -PRINT、 8 -P_EMPTY_LINE; PLC programming mode: read only, read out 0
40305-40306	0304-0305	Input1 mode	Range: 0-1 , 0 : Detect low levels, 1 : Detect high levels
40307-40308	0306-0307	Input1 Delay	Comp. Mode: parameter range 0ms-200ms , default 5ms ,

			PLC programming mode, read only, read out 0
40309-40310	0308-0309	Input2 function	Refer to input 1 function description
40311-40312	0310-0311	Input2 mode	Refer to input 1 pattern description
40313-40314	0312-0313	Input2 Delay	Refer to input 1 Delay description
40315-40316	0314-0315	Input3 function	Refer to input 1 function description
40317-40318	0316-0317	Input3 mode	Refer to input 1 pattern description
40319-40320	0318-0319	Input3 Delay	Refer to input 1 Delay description
40321-40322	0320-0321	ExIN1 Func	Refer to input 1 function description, can write when there is IO attached board, otherwise read only
40323-40324	0322-0323	ExIN1 Mode	Refer to input 1 mode instructions, only when there is IO attached board can write, otherwise read only
40325-40326	0324-0325	ExIN1 Delay	Refer to input 1 to shake instructions, IO attached board can only write, otherwise read only
40327-40328	0326-0327	ExIN2 Func	Refer to input 1 function description, can write when there is IO attached board, otherwise read only
40329-40330	0328-0329	ExIN2 Mode	Refer to input 1 mode instructions, only when there is IO attached board can write, otherwise read only
40331-40332	0330-0331	ExIN2 Delay	Refer to input 1 to shake instructions, IO attached board can only write, otherwise read only
40333-40334	0332-0333	OUT1 Func	Range 0-14, Correspondence: Nonfunctional, Stable, Zero, Net Weight, Printing, Negative Weight, Communications Heartbeat, Comparator 1, Comparator 2...The comparator 8
40335-40336	0334-0335	OUT1 Mode	Range:0-1, 0: low output, 1: high output
40337-40338	0336-0337	OUT2 Func	Refer to the output 1 function
40339-40340	0338-0339	OUT2 Mode	Refer to the output 1 pattern
40341-40342	0340-0341	OUT3Func	Refer to the output 1 function
40343-40344	0342-0343	OUT3Mode	Refer to the output 1 pattern
40345-40346	0344-0345	OUT4Func	Refer to the output 1 function
40347-40348	0346-0347	OUT4 Mode	Refer to the output 1 pattern
40349-40350	0348-0349	OUT5 Func	Refer to the output 1 function
40351-40352	0350-0351	OUT5Mode	Refer to the output 1 pattern
40353-40354	0352-0353	ExOUT1 Func	Refer to the output 1 function
40355-40356	0354-0355	ExOUT1 Mode	Refer to the output 1 pattern
40357-40358	0356-0357	ExOUT2Func	Refer to the output 1 function
40359-40360	0358-0359	ExOUT2 Mode	Refer to the output 1 pattern
40361-40362	0360-0361	ExOUT3 Func	Refer to the output 1 function
40363-40364	0362-0363	ExOUT3 Mode	Refer to the output 1 pattern

40365-40366	0364-0365	ExOUT4 Func	Refer to the output 1 function
40367-40368	0366-0367	ExOUT4 Mode	Refer to the output 1 pattern
40369~40500	0368~0499	Reserved	
40501-40502	0500-0501	COMP 1- Comp. Mode	Comp. Mode: parameter range: 0-12 , 0 -close, 1 -weight \leq 、 2 -weight=、 3 -weight \neq 、 4 -weight \geq 、 5 -weight \diamond 、 6 -weight $\leftarrow \rightarrow$ 、 7 -Flowrate \leq 、 8 -Flowrate=、 9 -Flowrate \neq 、 10 -Flowrate \geq 、 11 -Flowrate \diamond 、 12 -Flowrate $\leftarrow \rightarrow$ PLC programming mode: read only, read out 0
40503-40504	0502-0503	COMP 1- CompValue 1	Comp. Mode: CompValue 1 , directed number, range- 999999-999999 . PLC programming mode: read only, read out 0
40505-40506	0504-0505	COMP 1- CompValue 2	Comparing patterns: CompValue 2 , directed number, range- 999999-999999 . > CompValue 1 PLC programming mode: read only, read out 0
40507-40508	0506-0507	COMP 1- ON COND.	Range: 0-2 , correspond to: output, output after weight STAB, delay timer mode PLC programming mode: read only, read out 0
40509-40510	0508-0509	COMP 1- TRUE JudgeT	minimum decision time for success, range 0-5000ms , default 1000 PLC programming mode: read only, read out 0
40511-40512	0510-0511	COMP 1- OFF COND.	Range: 0-2 , correspond to: Invalid instant, invalid after weight STAB, delay timer mode. PLC programming mode: read only, read out 0
40513-40514	0512-0513	COMP 1- FALSE HoldT	Mini failure timer, range 0-5000ms , default 1000 PLC programming mode: read only, read out 0
40515-40520	0514-0519	Reserved	
40521-40540	0520-0539	COMP2 parameter	Refer to comparator 1 parameters
40541-40560	0540-0559	COMP3 parameter	
40561-40580	0560-0579	COMP4 parameter	
40581-40600	0580-0599	COMP5 parameter	
40601-40620	0600-0619	COMP6 parameter	
40621-40640	0620-0639	COMP7 parameter	
40341-40660	0640-0659	COMP8 parameter	
40661~48000	0660~7999	Reserved	
Communication parameter setting area, address range 4x08001-4x08300.Remote Settings (482X) are read-write when enabled, otherwise read-only			
48001	8000	COM0 COM0 ID	COM 0 COM0 ID; Range: 01-99

48002	8001	COM0 Baudrate	Range: 0-7 correspond to: 1200、2400、4800、9600、19200、38400、57600、115200 ; Initial value 5 (38400)
48003	8002	COM0 Protocol	Including: 0-Modbus/RTU, 1-Modbus/Ascii, 2-Cont-A, 3-Cont-B, 4-r-Cont, 5-rE-Cont, 6-YH, 7-print , default 0 (Modbus/RTU)
48004	8003	COM0 Data Format	Range: 0-8N1, 1-8E1, 2-8O1, 3-7E1, 4-7O1 Initial value: 1 (8E1)
48005	8004	COM0 DwordFormat	0-AB-CD, 1-CD-AB . Initial value: 0 (AB-CD)
48006	8005	COM0 Send Gap	Range 0-1000ms , default: 20ms
48007~48020	8006~48019	Reserved	
48021	8020	COM1 ID	Refer COM0 parameters
48022	8021	COM1 Baudrate	
48023	8022	COM1 Protocol	
48024	8023	COM1 Data Format	
48025	8024	COM1 DwordFormat	
48026	8025	COM1 Send Gap	
48027	8026	COM1 1-RS485; 0-RS232	
48028~48040	8027~8039	Reserved	
48041	8040	COM2 ID	Refer COM0 parameters
48042	8041	COM2 Baudrate	
48043	8042	COM2 Protocol	
48044	8043	COM2 Data Format	
48045	8044	COM2 DwordFormat	
48046	8045	COM2 Send Gap	
48047~48100	8046~8099	Reserved	
48101	8100	NetCom MODE	Protocol: 0-Modbus/TCP, 1-Cont-A/TCP, 2-Cont-B/TCP, 3-r-Cont/TCP, 4-rE-Cont/TCP, 5-YH/TCP . When choose Ethernet/IP,Profinet , this parameter can't be set
48102	8101	NetCom Hi-Lo	NetCom can set: 0-AB-CD, 1-CD-AB When choose Ethernet/IP、Profinet , this parameter can't be set.
48103	8102	NetCom Send Gap	1-Cont-A/TCP, 2-Cont-B/TCP, 3-r-Cont/TCP, 4-rE-Cont/TCP, 5-YH/TCP , parameter is used to set the interval between successive transmissions.Range: 0-1000ms
48104-48107	8103-8106	IP Config	The order is Part I to Part IV IP

48108-48111	8107-8110	DEST. IP	The order is Part I to Part IV IP
48112	8111	Socket	Range:0-65535, Network communication port number setting
48113	8112	NetCom DEST. IP	Range:0-65535, Network communication port number setting
48114-48117	8113-8116	Net port 0 subnet mask	Range:0-255, The subnet mask addresses of the transmitter part 1 through part 4 addresses
48118-48121	8117-8120	gateway	Range:0-255, Gateway addresses for the transmitter part 1 through part 4 addresses
48122-48150	8121-8149	Reserved	
48151	8150	DA0 Analogue output mode	0: 4-20mA; 1: 0-10V; 2: User voltage; 3: User current
48152	8151	DA0 Analogue Min output	Range:0-10000 or 0-24000, default 0. If it is not user mode, the readout will be 0 and the write will be invalid.
48153	8152	DA0 Zero analogue output	Range:0-10000 or 0-24000, default 0. If it is not user mode, the readout will be 0 and the write will be invalid.
48154	8153	DA0 full range analogue output	Range:0-10000 or 0-24000, default 0. If it is not user mode, the readout will be 0 and the write will be invalid
48155	8154	DA0 Analogue Max output	Range:0-10000 or 0-24000, default 0. If it is not user mode, the readout will be 0 and the write will be invalid
48156	8155	DA0 Analogue Link Data	0: display weight, 1: NW, 2: Gross and flowrate
48157-48200	8156-8199	Reserved	
48201	8200	HeaderLines	Range:0-4, select how many headerlines to use
48202	8201	EndLines	Range:-4, select how many endlines to use
48203	8202	Ticket Gap	Range:0-99, No. of lines between each print
48204	8203	Content	Range:0-6, option: 0、display weight, 1、Gross, 2、NW, 3、flowrate, 4、NW+ Gross (2 LINES), 5、Gross + flowrate, 6、All info (Gross +NW+ flowrate), default 0.
48205	8204	Print Lang	0: English 1: Chinese
48206	8205	Lines choose	Range:1-8, For header information 1-4 and tail information 1-4. It's going to be 0 when you put it on.After writing, read out is the value written
48207-48222	8206-8221	Character content of the	Support: 0-9, a-z, A-Z, ' space ', "- " Ascii

		printed message (16 characters)	code
48221~48250	8222~8249	Reserved	
48251~48256	8250~8255	Blue tooth Device Name 6 characters	Only support: 0-9, a-z, A-Z, ' space ' , "-" Ascii code
48257~48280	8256~8279	Reserved	
48281	8280	Blue tooth Language	0: Chinese 1: English
48282~48300	8281~8299	Reserved	
Transmitter test area that allows remote testing (523X) to be read and write, otherwise read only			
48301	8300	I/O test	Parameters range: 0-1 , 0: Exit I/O test mode, 1: enter serial port IO test mode, must be closed after the end of the test, the transmitter can enter the normal state.
48302	8301	Input1 TEST	Reading 0 means no input and reading 1 means there is input. Any value written is invalid and only valid in IO test mode
48303	8302	Input2 TEST	
48304	8303	Input3 TEST	
48305	8304	ExIN1 test	
48306	8305	ExIN2 test	
48307~48350	8306~8349	Reserved	
48351	8350	Output1 test	Range: 0-1 , write: 0 , close output, 1 , output ON (only valid in IO test mode), read out current IO state, 0: OFF, 1: ON
48352	8351	Output2 test	
48353	8352	Output3 test	
48354	8353	Output4 test	
48355	8354	Output5 test	
48356	8355	ExOUT1 test	
48357	8356	ExOUT2 test	
48358	8357	ExOUT3 test	
48359	8358	ExOUT4 test	
48360~48400	8359~8399	Reserved	
Analog calibration area address, address range 4x08401-4x08500, allow remote editing (584X) can read and write, otherwise read only			
48401	8400	DA0IN/OUT Analog CAL	Range: 0-2 , write: 0: ESC remote analogue CAL state; 1: Remote current CAL; 2: Remote vlot CAL. Remote edit (584x) Use after start.
48402	8401	DA0Current CALPoint1 digital code	Range: 0-65535 , write: The transmitter outputs current according to the write code. Available in current calibration mode

			only.
48403	8402	DA0 Current CAL Point1 Current value	Range: 0-24000 , Write the measured current value to complete the current calibration at the corresponding point. Available in current calibration mode only.
48404	8403	DA0 Current CAL Point2 digital code	
48405	8404	DA0 Current CAL Point2 current value	
48406	8405	DA0 Current CAL Point3 digital code	
48407	8406	DA0 Current CAL Point3 current value	
48408	8407	DA0 Current CAL Point4 digital code	
48409	8408	DA0 Current CAL Point4 current value	
48410	8409	DA0 Current CAL Point5 digital code	
48411	8410	DA0 Current CAL Point5 current value	
48412	8411	DA0 Voltage CAL Point1 digital code	
48413	8412	DA0 Voltage CAL Point1 current value	
48414	8413	DA0 Voltage CAL Point2 digital code	
48415	8414	DA0 Voltage CAL Point2 current value	
48416	8415	DA0 Voltage CAL Point3 digital code	
48417	8416	DA0 Voltage CAL Point3 current value	
48418	8417	DA0 Voltage CAL Point4 digital code	
48419	8418	DA0 Voltage CAL Point4 current value	
48420	8419	DA0 Voltage CAL Point5 digital code	
48421	8420	DA0 Voltage CAL Point5 current value	
48422~48600	8421~8599	DA0 reserved	
Function operation class address area (corresponding to the coil function), condition can read and write			
48601	8600	ZERO	Write 1 Read 0
48602	8601	TARE	
48603	8602	CLEAR TARE	
48604	8603	GW/NW	
48605	8604	ZEROING	
48606	8605	PRINT	
48607	8606	P_EMPTY_LINE	
48608~48900	8607~8899	Reserved	
48901	8900	All parameter reset	Write 1 to perform the corresponding reset operation read out is 0
48902	8901	Part parameter reset (All do not include calibration)	
48903	8902	Cal Reset	
48904	8903	Basic parameter reset	

48905	8904	I/O define reset	
48906	8905	DA Cal RST.	
48907	8906	App Reset	
48908	8907	Reset	
48908~48980	8907~8979	Reserved	
48981~48988	8980~8987	Edit the boot LOGO character 1-8 (8 characters)	The sequence corresponds to the 1-8 characters of the boot logo. ASCII code should be written in the range of 0-9,A-Z, A-Z, and space, '-'
48989~49000	8988~8999	Reserved	
Transmitter system information area, address range, read-only area			
410001	10000	Version (Hi word)	
410002	10001	Version (Lo word)	Read out 10000 , 01.00.00 ver.
410003	10002	Edit time (year)	
410004	10003	Edit time (Month/Day)	
410005~410017	10004~10016	The transmitter serial number is 13 characters	
410018~410029	10017~10028	The transmitter encodes 12 characters	
410030	10029	Reserved	
410031~410040	10030~10039	The transmitter models have 10 characters	
410041	10040	Additional board 01 information	
410042	10041	Additional board 02 information	
410043~410100	10042~10099	Reserved	
410101~410106	10100~10105	NetCom 0 transmitter MAC address	
410107~410112	10106~10111	NetCom 1 transmitter MAC address	
410113~410118	10112~10117	Blue tooth Mac address	
410119~410200	10118~10199	Reserved	
410201	10200	Basic parameter remote edit	ON/OFF Status bit, READY ONLY: READ OUT: 0 , OFF; 1 , ON
410202	10201	Basic parameter PWD Protect	
410203	10202	Remote CAL	
410204	10203	CAL hardware protect	
410205	10204	CAL PWD Protect	
410206	10205	Application parameter remote	
410207	10206	Application parameter PWD Protect	
410208	10207	Communication parameter remote edit	
410209	10208	Communication parameter PWD Protect ON/OFF	
410210	10209	Remote editing of system maintenance parameters	

410211	10210	System maintenance parameters are password protected	
Coil address			
0x0001	0000	ZERO	Content read and write coil WRITE: FF00H = ON 0000H = OFF READ: 0001H = ON 0000H = OFF
0x0002	0001	TARE	
0x0003	0002	CLEAR TARE	
0x0004	0003	GROSS/NET	
0x0005	0004	ZEROING	
0x0006	0005	PRINT	
0x0007~0x0300	0006~0299	Reserved	
0x0301	300	All parameter reset	WRITE ONLY WRITE: FF00H = Perform reset READ: 0000H
0x0302	301	Part parameter reset	
0x0303	302	CAL reset	
0x0304	303	Basic parameter reset	
0x0305	304	I/O define reset	
0x0306	305	Analogue CAL reset	
0x0307	306	Application parameter reset	
0x0308	307	Communication parameter reset	
0x0309~0x0400	308~399	Reserved	
0x0401	0400	IN1 STATE	READ ONLY Readout returns an input port state 0: invalid; 1valid
0x0402	0401	IN2 STATE	
0x0403	0402	IN3 STATE	
0x0404	0403	Ext. IN1 STATE	
0x0405	0404	Ext. IN2 STATE	
0x0406~0x0450	0405~0449	Reserved	
0x0451	0450	OUT1 STATE	READ ONLY Readout returns an output port state 0: invalid; 1valid
0x0452	0451	OUT2 STATE	
0x0453	0452	OUT3 STATE	
0x0454	0453	OUT4 STATE	
0x0455	0454	OUT5 STATE	
0x0456	0455	Ext. OUT1 STATE	
0x0457	0456	Ext. OUT2 STATE	
0x0458	0457	Ext. OUT3 STATE	
0x0459	0458	Ext. OUT4 STATE	
0x0460~0x0500	0459~0499	Reserved	
0x0501	0500	Remote edit (basic parameter)	READ ONLY PARAMETER
0x0502	0501	PWD Protect (basic parameter)	
0x0503	0502	Remote CAL (CAL parameter)	

0x0504	0503	HWD. Protect (CAL parameter)
0x0505	0504	PWD Protect (CAL parameter)
0x0506	0505	Remote edit (Application parameter)
0x0507	0506	PWD Protect (Application parameter)
0x0508	0507	Remote edit (Communication parameter)
0x0509	0508	PWD Protect (Communication parameter)
0x0510	0509	Remote edit (Maintenance parameter)
0x0511	0510	PWD Protect (Maintenance parameter)
0x0512~0x0800	0511~0799	Reserved

10.2 Continuous send A (CB920)

When GMT-X1 serial port protocol choose "Continuous send A (CB920)", send data according to below format.

State	0	Content	0/1	+/-	display value	Unit	CR	LF
2unit	30	2unit	30	2B/2D	7unit	2unit	0D	0A

State—— 2unit, **OL**: (4FH 4CH) overflow; **ST**: (53H 54H)stable; **US**: (55H 53H)unstable

Gross—— 2unit, **GS(gross)**: 47H 53H ; **NT(net weight)**: 4EH 54H; **FR(floware)**: 46H 52H

0/1—— 1unit, (30H/31H) interleave send.

unit—— 2unit, Eg: **kg**: 6BH 67H; **G**: 20H 67H etc

Eg: When the transmitter automativally sends folling data.

53 54 30 47 53 30 2B 20 20 20 20 32 35 34 6B 67 0D 0A

It can be known that the current transmitter state is stable, gross weight, data value is positive, and current weight value is **254 kg**

10.3 Cont-B (Continuous send -tt)

When GMT-X1 serial port protocol is selected as "continuous transmission B (TT)", the collected data will be automatically sent to the master computer

STX	State1	State 2	State 3	Display value	Load cell voltage	CR	Cali and
02H	1Unit	1Unit	20H	6Unit	6Unit (0D	1Unit

Status 1:

bit7	bit6		bit5	bit4		bit3	bit2		bit1	bit0
Fix 0	/h	1	0	t	0	0	0	0	1	0
	/m	1	1	Kg	0	1	0.0	0	1	1
				g	1	0	0.00	1	0	0
				Lb	1	1	0.000	1	0	1
							0.0000	1	1	0
Flow unit				Weight Unit			Decimal			

Status 2:

bit7	bit6	bit5	bit4	bit3	bit2	bit1	bit0
Reserved	Reserved	Reserved	1- Flow	1-Unstable	1-overflow	1-negative	1-NT
Fix 0	Fix 1	Fix 1	0- Weight	0-stable	0-normal	0-postive	0-Gross

10.4 r-Cont

When **GMT-X1** serial port protocol choose “**r-Cont**”, Without sending any command to the weight transmitter, the data collected will be automatically sent to the computer in the following format.

STX	Scale No.	Gateway No.	State1	State 2	Display value	CRC	CR	LF
02H	2Unit	31H	1 Unit	1Unit	6 Unit	2 Unit	0D	0A

Scale-----2unit, range 01~99

State1-----1unit

bit7	bit6		bit5	bit4		bit3	bit2		bit1	bit0
Fix0	/h	1	0	t	0	0	0	0	0	0
	/m	1	1	Kg	0	1	0.0	0	0	1
				g	1	0	0.00	0	1	0
				Lb	1	1	0.000	0	1	1
							0.0000	1	0	1
Flow unit			Weight Unit			Decimal				

State2-----1unit

D6	D5	D4	D3	D2	D1	D0
No define	No define	Gross/NET	+/-	0	overflow	Stable
FIX:1	FIX:0	Gross 0; NET 1;	0: + 1: -	0: non 0 1: 0	0: normal 1: overflow	0: Un Stable 1: Stable

Weight Value —— 6-bit unsigned number;Returns "blank space OFL space" when weight is positive (negative) overflow.

CRC—— **2 Unit, Cal and**

All the values in front of the check bits are added up and converted to decimal data, and then the last two bits are converted to ASCII (tens before, ones after).For example

If there is one of the following frames:

02	30	31	43	47	4F	4B	39	31	0D	0A
----	----	----	----	----	----	----	----	----	----	----

The sum of 02~4B is 187 (Hex), which is converted to decimal as 391.It can be

calculated that the check codes of this data frame are 39 and 31

Example:

The current transmitter automatically returns data: **02 30 31 31 40 41 20 20 20 37 30 30 32 34 0D 0A**

The current transmitter state is stable, the weight value is positive, and the current weight value is 700.

10.5 rE-Cont

In this way, no need to send any command to the weighing display, and the display will automatically send the collected data to the computer

Return data frame format description:

State	,	Content	,	+/-	Display value	Unit	CR	LF
2Unit	2C	2Unit	2C	2B/2D	7Unit	2Unit	0D	0A

State——**2Unit**, **OL**(Overflow):**4FH 4CH**; **ST** (stable):**53H 54H**; **US** (Unstable):**55H 53H**

Content——**2Unit**, **GS**(Gross weight): **47H 53H** ; **NT**(Net weight): **4EH 54H** ;
FR(floware): **46H 52H**

Display value—— **7Unit**, Include Decimal, When no Decimal, high way is empty

Unit—— **2Unit**, Eg **kg**: **6BH 67H**; **g**:**20H 67H**etc

Eg:

When the weighing display automatically sends the following frame of data:

53 54 2C 47 53 2C 2D 20 20 20 32 36 37 20 74 0D 0A

The current state is stable, the data value is positive, and the display value is -267t.

10.6 YH Protocol

When **GMT-X1** serial port protocol choose “**YH** protocol” , Transfer data in the following format.Under this protocol, the data is output in ASCII code, and each frame consists of 9 groups (including the decimal point).Data transmission starts with low and then high. There is a set of delimiter "=" between each frame of data. The data sent is gross weight, such as the current gross weight of 70.15, continuous transmission of 51.0700=51.0700...

Eg: **123.9**

Bit0	Bit1	Bit2	Bit3	Bit4	Bit5	Bit6	Bit7	Bit8
=	9	.	3	2	1	0	0	0

High point is not enough to fill 0, the decimal point accounts for 1 byte, and when a negative number is negative, Bit8 is a negative sign "-".

10.7 PROFINET Protocol

The **GMT-X1** display has two **PROFINET-IO** bus connection ports, **NET1** and **NET2**, which can be used as a **PROFINET-IO** slave station to connect to the **PROFINET** bus.

IP address of instrument is set and viewed in parameter item 444X; The **MAC** address is viewed in item 571x.

10.7.1 IO state

GMT-X1 provides multi-byte IO output in two modules, through which the master station can read and control the state of the weighing display.

Module1: Weight and status parameters (read register)

Offsets			
weight	Parameter	Data type	Description
0	Display weight	DInt	The current weight of the display, integral type
4	Weight status marker bit	Word	D13-D15 Reserved
			D12: bipolar, (When bipolar is selected, the flag bit is valid)
			D11: Calculate the weight using the theoretical value (prompt the user when calculating the weight using the theoretical value)
			D10: ADC failure (ADC initialization failure or sampling interruption longer than expected)
			D9: Net weight of the current display, (distinguish which weight is currently displayed)
			D8: Million volt stability, (mark of million volt stability in calibration)
			D7: Negative load cell overflow, lower than the allowable range of load cell voltage
			D6: The load cell is overflowing, beyond the allowable range of load cell voltage
			D5: Weight negative overflow, weight less than "-(maximum range + 9D)"
			D4: The weight is positive overflow, the weight is greater than "maximum range + 9D"
			D3: Overflow state, (weight or load cell abnormality)
			D2: Display weight minus sign, (display weight is a negative number)
			D1: Zero, (weight in the range of 0+/- 1/4 D)
D0: Stable			
6	Error code 1	Word	D13-D15 Reserved
			D12: Remote calibration is performed when remote calibration is prohibited
			D11: The calibration is in hardware protection
			D10: The previous weight point is not calibrated
			D09: Beyond the minimum resolution (less than 0.1uV)

			per subdivision)
			D08: Weight input exceeds the maximum range
			D07: The weight input cannot be zero
			D06: Weight calibration less than zero or the previous standard point
			D05: Load cell overflow is positive during weight calibration
			D04: Negative load cell overflow during weight calibration
			D03: The weight calibration is not stable
			D02: Load cell overflow is positive during zero calibration
			D01: Negative load cell overflow during zero calibration
			D00: The zero calibration is not stable
8	Error code 2	Word	D14–D15 Reserved
			D13: The remote tare operation permit switch is not enabled when the tare is operated remotely
			D12: Net weight status does not allow tare
			D11: When tare, the weight is negative
			D10: Load cells overflow when tare
			D09: Negative load cell overflow during tare
			D08: Unstable when tare
			D07: The net weight status is not allowed to be cleared
			D06: The remote reset switch is not turned on during remote reset
			D05: The load cell is overflowing when zero is cleared
			D04: Negative load cell overflow during zero clearance
			D03: Zero clearance is unstable
			D02: Clear out of range
			D01: Unstable when reset on power
D00: Power on clear zero out of range			
10	Process status flag bits	Word	D13–D15 Reserved
			D11: Current calibration under way
			D10: Voltage calibration under way
			D9: IO Testing state
			D8: In printing, (valid when the meter is performing printing operation)
			D7: The comparator 8 reaches, (the comparison condition

			is valid if the comparator 8 reaches)
			D6: The comparator 7 reaches, (the comparison condition is valid if the comparator 7 reaches)
			D5: The comparator 6 reaches, (the comparison condition is valid if the comparator 6 reaches)
			D4: The comparator 5 reaches, (the comparison condition is valid if the comparator 5 reaches)
			D3: The comparator 4 reaches, (the comparison condition is valid if the comparator 4 reaches)
			D2: The comparator 3 reaches, (the comparison condition is valid if the comparator 3 reaches)
			D1: The comparator 2 reaches, (the comparison condition is valid if the comparator 2 reaches)
			D0: The comparator 1 reaches, (the comparison condition is valid if the comparator 1 reaches)
12	Gross	DInt	Gross value (Signed integers)
16	Net weight	DInt	Net weight value (Signed integers)
20	Tare	DInt	Tare value (Signed integers)
24	Flow	DInt	Flow value (Signed integers)
28	Current weight	Float	Current display weight, floating-point type
32	Gross	Float	Gross value, floating-point type
36	Net weight	Float	Net weight value, floating-point type
40	Tare	Float	Tare value, floating-point type
44	Flow	Float	Flow value, floating-point type
48	AD code after filtering	DWord	AD code after filtering
52	Sensor voltage data	DWord	Signed numbers, integers, four decimal points
56	Relative zero voltage value data	DWord	Signed numbers, integers, four decimal points
60	Input state area	Word	D5-D15 Reserved
			D4: Enter 5 state (Expand input 2)
			D3: Enter 4 state (Expand input 1)
			D2: Enter 3 state
			D1: Enter 2 state
			D0: Enter 1 state
62	Output state area	Word	D9-D15 Reserved
			D8: Output 9 state (Expand input 4)
			D7: Output 8 state (Expand input 3)
			D6: Output 7 state (Expand input 2)

			D5: Output 6 state (Expand input 1)
			D4: Output 5 state
			D3: Output 4 state
			D2: Output 3 state
			D1: Output 2 state
			D0: Output 1 state
64	Heartbeat communication	Word	The value of PN's communication heartbeat is always 1 after the connection is established, and the communication light is always on. After flashing the LED light, the communication light will blink at the frequency of 1Hz, and the value of communication heartbeat will also convert between 0 and 1 at the frequency of 1Hz

Module2: Calibration parameters (read/write register)

Offsets			
weight	Parameter	Data type	Description
0	Automatic zero	DWord	Current sensor voltage
4	Gain point 1	DWord	Relative voltage value 1 (sensor input - zero voltage)
8	Gain point 2	DWord	Relative voltage value 2 (sensor input - 1 voltage at reference point)
12	Gain point 3	DWord	Relative voltage value 3 (sensor input -2 voltage at reference point)
16	Gain point 4	DWord	Relative voltage value 4 (sensor input - 3 voltage at reference point)
20	Gain point 5	DWord	Relative voltage value 5 (sensor input - 4 voltage at reference point)
0	Automatic zero	DWord	Current sensor voltage (write 1 to the communication address to perform automatic acquisition of zero calibration)
4	Gain point 1	DWord	Relative voltage value 1 (sensor input - zero voltage)
8	Gain point 2	DWord	Relative voltage value 2 (sensor input - 1 voltage at reference point)
12	Gain point 3	DWord	Relative voltage value 3 (sensor input - 2 voltage at reference point)
16	Gain point 4	DWord	Relative voltage value 4 (sensor input - 3 voltage at reference point)
20	Gain point 5	DWord	Relative voltage value 5 (sensor input - 4 voltage

Read the register

Write register (address write value to complete calibration)

			at reference point)	
24	Function state	Word	D7-D15 Reserved	
			D6: P_EMPTY_LINE	
			D5: Print	
			D4: Cal zero	
			D3: Gross/Net weight	
			D2: Clear Tare	
			D1: Tare	
			D0: Zero	

10.7.2 Device description file GSD

The device description file and connection method of GMT-X1 can be downloaded from the website of Shenzhen General Measure Technology Co., Ltd. (www.szgmt.com).

10.8 EtherNet-IP Protocol

IP address of controller is set and viewed in parameter item 444X; The MAC address is viewed in item 571x.

10.8.1 IO state

GMT-X1 provides multi-byte IO through which the host station can read and control the status of the weighing display.

Module 1: Weight and status parameters (read register)

Offsets			
weight	Parameter	Data type	Description
0	Display weight	DInt	The current weight of the display, integral type
2	Weight status marker bit	Word	D13-D15 Reserved
			D12: bipolar, (When bipolar is selected, the flag bit is valid)
			D11: Calculate the weight using the theoretical value (prompt the user when calculating the weight using the theoretical value)
			D10: ADC failure (ADC initialization failure or sampling interruption longer than expected)
			D9: Net weight of the current display, (distinguish which weight is currently displayed)
			D8: Million volt stability, (mark of million volt stability in calibration)
			D7: Negative load cell overflow, lower than the

			allowable range of load cell voltage
			D6: The load cell is overflowing, beyond the allowable range of load cell voltage
			D5: Weight negative overflow, weight less than "-(maximum range + 9D)"
			D4: The weight is positive overflow, the weight is greater than "maximum range + 9D"
			D3: Overflow state, (weight or load cell abnormality)
			D2: Display weight minus sign, (display weight is a negative number)
			D1: Zero, (weight in the range of 0+/- 1/4 D)
			D0: Stable
3	Error code 1	Word	D13–D15 Reserved
			D12: Remote calibration is performed when remote calibration is prohibited
			D11: The calibration is in hardware protection
			D10: The previous weight point is not calibrated
			D09: Beyond the minimum resolution (less than 0.1uV per subdivision)
			D08: Weight input exceeds the maximum range
			D07: The weight input cannot be zero
			D06: Weight calibration less than zero or the previous standard point
			D05: Load cell overflow is positive during weight calibration
			D04: Negative load cell overflow during weight calibration
			D03: The weight calibration is not stable
			D02: Load cell overflow is positive during zero calibration
			D01: Negative load cell overflow during zero calibration
D00: The zero calibration is not stable			
4	Error code 2	Word	D14–D15 Reserved
			D13: The remote tare operation permit switch is not enabled when the tare is operated remotely
			D12: Net weight status does not allow tare
			D11: When tare, the weight is negative

			D10: Load cells overflow when tare D09: Negative load cell overflow during tare D08: Unstable when tare D07: The net weight status is not allowed to be cleared D06: The remote reset switch is not turned on during remote reset D05: The load cell is overflowing when zero is cleared D04: Negative load cell overflow during zero clearance D03: Zero clearance is unstable D02: Clear out of range D01: Unstable when reset on power D00: Power on clear zero out of range
5	Process status flag bits	Word	D13–D15 Reserved D11: Current calibration under way D10: Voltage calibration under way D9: IO Testing state D8: In printing, (valid when the meter is performing printing operation) D7: The comparator 8 reaches, (the comparison condition is valid if the comparator 8 reaches) D6: The comparator 7 reaches, (the comparison condition is valid if the comparator 7 reaches) D5: The comparator 6 reaches, (the comparison condition is valid if the comparator 6 reaches) D4: The comparator 5 reaches, (the comparison condition is valid if the comparator 5 reaches) D3: The comparator 4 reaches, (the comparison condition is valid if the comparator 4 reaches) D2: The comparator 3 reaches, (the comparison condition is valid if the comparator 3 reaches) D1: The comparator 2 reaches, (the comparison condition is valid if the comparator 2 reaches) D0: The comparator 1 reaches, (the comparison condition is valid if the comparator 1 reaches)
6	Gross	DInt	Gross value (Signed integers)
8	Net weight	DInt	Net weight value (Signed integers)
10	Tare	DInt	Tare value (Signed integers)
12	Flow	DInt	Flow value (Signed integers)

14	Current weight	Float	Current display weight, floating-point type			
16	Gross	Float	Gross value, floating-point type			
18	Net weight	Float	Net weight value, floating-point type			
20	Tare	Float	Tare value, floating-point type			
22	Flow	Float	Flow value, floating-point type			
24	AD code after filtering	DWord	AD code after filtering			
26	Sensor voltage data	DWord	Signed numbers, integers, four decimal points			
28	Relative zero voltage value data	DWord	Signed numbers, integers, four decimal points			
30	Input state area	Word	D5-D15 Reserved			
			D4: Enter 5 state (Expand input 2)			
			D3: Enter 4 state (Expand input 1)			
			D2: Enter 3 state			
			D1: Enter 2 state			
31	Output state area	Word	D0: Enter 1 state			
			D9-D15 Reserved			
			D8: Output 9 state (Expand input 4)			
			D7: Output 8 state (Expand input 3)			
			D6: Output 7 state (Expand input 2)			
			D5: Output 6 state (Expand input 1)			
			D4: Output 5 state			
			D3: Output 4 state			
32	Heartbeat communication	Word	D2: Output 3 state			
			D1: Output 2 state			
			D0: Output 1 state			
			The value of PN's communication heartbeat is always 1 after the connection is established, and the communication light is always on. After flashing the LED light, the communication light will blink at the frequency of 1Hz, and the value of communication heartbeat will also convert between 0 and 1 at the frequency of 1Hz			
			33	Automatic zero	DWord	Current sensor voltage
			35	Gain point 1	DWord	Relative voltage value 1 (sensor input - zero voltage)
			37	Gain point 2	DWord	Relative voltage value 2 (sensor input - 1 voltage at reference point)
			39	Gain point 3	DWord	Relative voltage value 3 (sensor input -2 voltage at

			reference point)	
41	Gain point 4	DWord	Relative voltage value 4 (sensor input - 3 voltage at reference point)	
43	Gain point 5	DWord	Relative voltage value 5 (sensor input - 4 voltage at reference point)	
0	Automatic zero	DWord	Current sensor voltage (write 1 to the communication address to perform automatic acquisition of zero calibration)	The address is written to the value to complete the calibration
2	Gain point 1	DWord	Relative voltage value 1 (sensor input - zero voltage)	
4	Gain point 2	DWord	Relative voltage value 2 (sensor input - 1 voltage at reference point)	
6	Gain point 3	DWord	Relative voltage value 3 (sensor input - 2 voltage at reference point)	
8	Gain point 4	DWord	Relative voltage value 4 (sensor input - 3 voltage at reference point)	
10	Gain point 5	DWord	Relative voltage value 5 (sensor input - 4 voltage at reference point)	
12	Function state	Word	D7-D15 Reserved	
			D6: P_EMPTY_LINE	
			D5: Print	
			D4: Cal zero	
			D3: Gross/Net weight	
			D2: Clear Tare	
			D1: Tare	
D0: Zero				

10.8.2 Device description file EDS

The device description file and connection method of GMT-X1 can be downloaded from the website of Shenzhen General Measure Technology Co., Ltd. (www.szgmt.com).

11. DIMENSION

