

AF-25K II -103B /AF-50 K II -103B

Auto filler

Operating instruction

杰·曼·科·技

Ver A1

Content

1.	overview.....	1
1.1	Product parameters, functions and features	1
1.1.1	Product parameters.....	1
1.1.2	Product features.....	1
1.1.3	Product features.....	2
1.2	Working principle.....	2
1.3	Main purpose and scope of application	2
2.	Precautions for safe use.....	3
2.1	Safe operation.....	3
2.1.1	Basic Safety Instructions.....	3
2.1.2	Operation safety instructions.....	3
3.	Product installation and transportation protection	5
3.1	The overall appearance and mechanism of the product are introduced	5
3.2	The installation conditions	6
3.2.1	Equipment installation basis and installation conditions.....	6
3.3	Unpacking and inspection	6
3.3.1	The crates	6
3.3.2	Spare parts.....	7
3.4	Product packaging and transportation protection	7

3.4.1	Packaging requirements	7
3.4.2	Transport protection	8
3.4.3	Remove transport limit protection	8
3.4.4	Requirements for equipment installation and maintenance ...	9
4.	Product size.....	10
4.1	AF-25KII-103B Overall dimensions.....	11
4.2	AF-50KII-103B Overall dimensions	13
5.	Electrical connections.....	15
5.1	Air supply connection.....	15
5.2	Electrical connections	15
5.2.1	External interface definition.....	16
5.2.2	Switching value interface wiring description	17
6.	The Modbus address table	19
7.	Touch screen Operation Instructions (optional)	42
7.1	Login screen	42
7.2	Touch screen login permission description	43
7.3	Main Interface description	44
7.4	The parameter setting page is described.....	46
7.5	Description of working parameters.....	48
7.6	Description of formula parameters	54
7.7	The Quick Mode Parameters interface says	57

7.8	Calibration interface description.....	59
7.9	Step of weight calibration	60
7.10	Material calibration steps	60
7.11	Description of switch quantity interface	62
7.12	Control Parameters screen Description.....	67
7.13	Communication Parameters screen description	70
7.14	Historical data page description.....	71
7.15	Description of automatic balance adjustment interface	72
7.16	Describes the user management interface	74
7.17	System information interface description	75
8.	Basic Function description	77
8.1	Basic running process	77
8.2	Overage and underage detection function	77
8.3	Overage and underage detection function	78
9.	Common failure analysis and troubleshooting	80
10.	Maintenance and warranty.....	81

Shenzhen General Measure Technology Co., Ltd. All rights reserved.

Without the permission of Shenzhen General Measure Technology Co., Ltd., no unit or individual shall reproduce, disseminate, transcribe or translate into any other language version in any form or means.

As our products are constantly improving and updating, we reserve the right to modify this manual at any time without prior notice. To this end, please visit the company website frequently for timely information.

Company website: <http://www.gmweighing.com>

1. overview

AF-25KII-103B / AF-50KII-1036B automatic quantification unit is a weighing component for automatic quantification of granular materials. The feeding mechanism adopts the mode of "motor + vibration feeder" to realize multi-stage feeding, and the unloading is driven by cylinder to realize fast unloading. The product has the characteristics of high speed, high precision and wide range, which can be widely used in the quantitative packaging machinery of grain, feed, chemical, rubber and plastic industries.

1.1 Product parameters, functions and features

1.1.1 Product parameters

model	AF-25KII-103B	AF-50KII-103B
Electrical source	AC220V±10%, 50/60Hz, 2000W	AC220V±10%, 50/60Hz, 2000W
The quantitative range	5~25kg	10~50kg
The weighing accuracy	±10g	±20g
Weighing speed	≥1600pcs/hour	≥1500pcs/hour
Metering bucket volume	55L*2	86L*2
Working temperature	0~40°C	0~40°C
Maximum humidity	90% OF R.H is not dewy	90% OF R.H is not dewy
Gas source	0.4 ~ 0.6 MPa after 2 m/h	0.4 ~ 0.6 MPa after 2 m/h

Note: packaging accuracy and speed may fluctuate due to material, feed and other environmental factors. The precision and speed are the test data of using round grain rice in our company's test line.

1.1.2 Product features

1. Automatic weighing function.
2. Three material speed (free blanking + vibration feeding) feeding control.
3. Automatic zero clearing function.
4. Automatic correction function of process control parameters.

5. Accumulative and statistical functions.

1.1.3 Product features

1. Intelligent: only set the target value, and automatically adjust the optimal quantitative speed under the condition of ensuring the accuracy.
2. Simple installation: standard external interface flange, quick installation.
3. Data export: with USB interface, data record export is more convenient.
4. Simple operation: 7 inch /10 inch touch screen, Chinese and English display (optional).
5. Material: 304 stainless steel for contact material.
6. High speed, high precision: the combination of feeding (free feeding + vibration feeding), both fast and accurate.

1.2 Working principle

The equipment starts the three-material fast feeding process, namely: fast, medium and slow feeding. The switch of each speed feeding takes the corresponding advance quantity in the formula as the control cut-off point. In order to avoid the influence of overshoot on measurement, the corresponding prohibition discriminant time is set. After feeding, enter the value setting process, the value setting time can be set, after the end of the value, the equipment through the switch output "feeding complete" signal; The equipment receives the external "unloading" effective switching signal, the equipment will drive the cylinder to open the unloading door of the metering bucket, when the weight of the material in the metering bucket is lower than the zero zone value set before, the equipment drives the cylinder to close the unloading door, complete a quantitative process; Before starting the next quantification process, the equipment carries out a pre-feeding delay, and then the next feeding, and so on.

1.3 Main purpose and scope of application

The AF-25KII-103B / AF-50KII-103B equipment is mainly designed for quantitative packaging of granular materials of 25kg/50kg and below. It can be used together with vacuum shaping packaging machine. Measurable materials are mainly rice and grains of small size (such as millet, soybean, mung bean, etc.)

2. Precautions for safe use

2.1 Safe operation

Before installing and using the product, read the product instruction carefully and have the equipment tested by professional personnel

2.1.1 Basic Safety Instructions

1. The power supply meets the requirements of this manual, and the equipment grounding meets the requirements.
2. Power and air should be turned off before starting cleaning, maintenance and repair.
3. Only use cleaners that do not damage mechanical and electrical equipment.
4. The mounting frame connected with the product should be stable and reliable.
5. Please cut off the power supply and air source when installing the metering bucket.
6. metering bucket, sensor connected parts and sensors are not allowed to knock, overload and other damage to the sensor behavior.
7. During the use of the equipment, no part of the body is allowed to extend into the equipment, and the weigher door has been firmly installed before use.
8. Machines that pack materials harmful to human body should be cleaned after using special protective tools according to the existing regulations of the country where the machines are operated. For details, please contact the relevant local authorities.

2.1.2 Operation safety instructions

1. In order to avoid dangerous accidents, only one person is allowed to operate the machine.
2. The machine should only be operated by properly trained personnel.
3. Operating instructions, especially safety instructions and regulations, must be read and fully understood by the operator (or anyone responsible for operating the machine) before the machine is run.
4. Before the machine runs, the operator must check whether the scale works normally, whether the machine is fixed and the appearance is normal.

5. In case of any danger, click the "emergency stop" button on the main interface or disconnect the main power supply immediately.
6. For the electrical and electronic system, it is not allowed to modify, replace or carry out any other non-standard operation; Any updates or modifications must be made by General Measure technologies.
7. Wear safety helmets and other protective devices when maintaining equipment, especially when entering the packaging area.
8. Be careful to step on or off the maintenance platform.

3. Product installation and transportation protection

3.1 The overall appearance and mechanism of the product are introduced

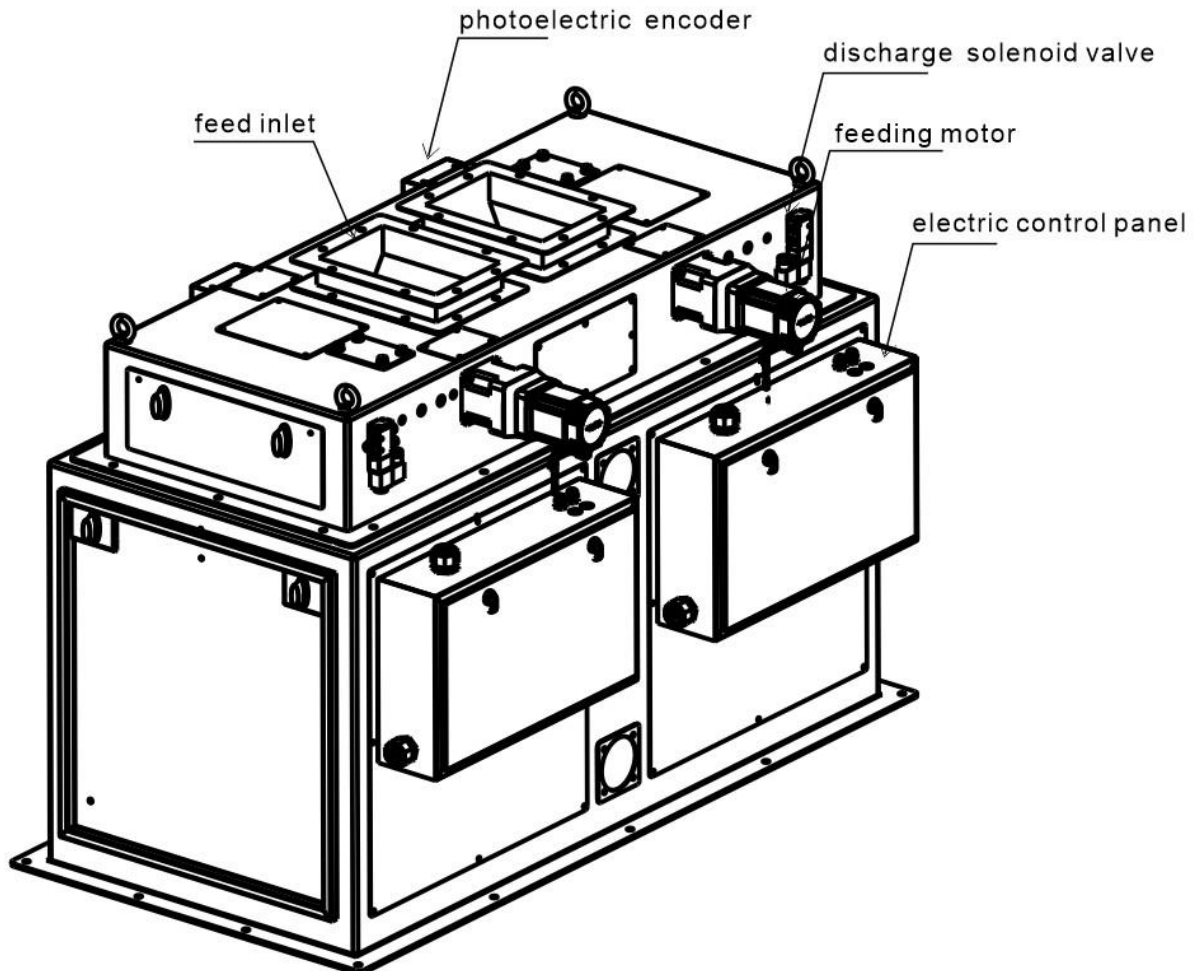

Material by the materials into the mouth, including three quantitative process speed feeding control (motor control of the coarse/fine + vibrating feeder feeding material), quantitative weighing type and discharging control, equipment control system can automatically according to the different of material and range correction process parameters, reducing the complexity of equipment debugging and maintenance, convenient supporting customers to use. When using, 0.4~ 0.5mpa, 2m³/h compressed air is needed to access the air source inlet, and the power supply, signal communication and control ports

(such as serial port connection end, USB connection and I/O control port) of the equipment are located in the electrical control box.

The double scales are arranged symmetrically according to the direction shown. Scale A is on the left and scale B is on the right. Contains the following parts:

Feeding port: the material to be weighed enters the scale body.

Photoelectric code plate: motor in position signal feedback.

Discharge solenoid valve: Control the action of the unloading cylinder.

Feeding motor: The main function of weighing is to control the feeding amount.

Electric control panel: The built-in circuit board is connected to external signals, I/O control connections, and power wiring.

3.2 The installation conditions

3.2.1 Equipment installation basis and installation conditions

1. Temperature: $-10\sim 40^{\circ}\text{C}$
2. Humidity: not more than 90% R.H.
3. Power supply: AC110~260V, 50Hz/60Hz, about 500W.
4. Air source: 0.4~ 0.5mpa 1.2m³/h.
5. Installation plane: horizontal solid steel support frame.
6. Static electricity: Ensure that the device is reliably grounded.
7. Harmful radio waves: keep away from powerful sources of harmful radio waves such as wireless devices.
8. Electrical and gas technical parameters meet and are in place

3.3 Unpacking and inspection

3.3.1 The crates



Please read this operation manual carefully before unpacking for

1. Pay attention to the words and warning signs on the containers before unpacking them.

2. Before unpacking the box, check whether the box is seriously squeezed and deformed during transportation. If the damage is serious, consider whether the equipment is damaged.
3. Read the packing list before unpacking and proofread it after unpacking to avoid omission.
4. After unpacking the device, check whether the screws connecting the device are loose.
5. Check whether the metal hose is in good condition before unpacking the device.
6. After unpacking the whole machine, check whether the scale is normal and whether the action of the moving parts is normal.
7. During debugging after the assembly of the unpacked machine, pay attention to whether the sealing of the parts through which the material passes under the predetermined pressure is reliable. This check must be made before starting the machine.

3.3.2 Spare parts

1. Accessories: equipment side panel opening key, packing list, invoice, product manual and quality inspection certificate.
2. Unpack the device and check whether the accessories are complete and whether the device package is intact.
3. Original General Measure Technologies must be used.

The company is not responsible for the loss caused by using other parts.

If you have any questions, please don't hesitate to contact us.

3.4 Product packaging and transportation protection

3.4.1 Packaging requirements

1. It is packaged in wooden cases and can be stacked in two layers.
GB/T4857.3 Basic Test for Transport Packages, Static Load Stacking Test Method.

2. Meet the vibration resistance requirements of long-distance highway transportation, GB/T4857.7 Basic Test for Transportation Packages, Sinusoidal Vibration (Constant Frequency) Test Method.

3.4.2 Transport protection

1. Before transportation, remove the metering bucket and invert it into the scale frame.
2. Use nuts at the lower flange of the equipment to secure the equipment to the transportation wooden box, and secure the unloading hopper.
3. Wrap the outer surface of the equipment with wrapping film.

3.4.3 Remove transport limit protection

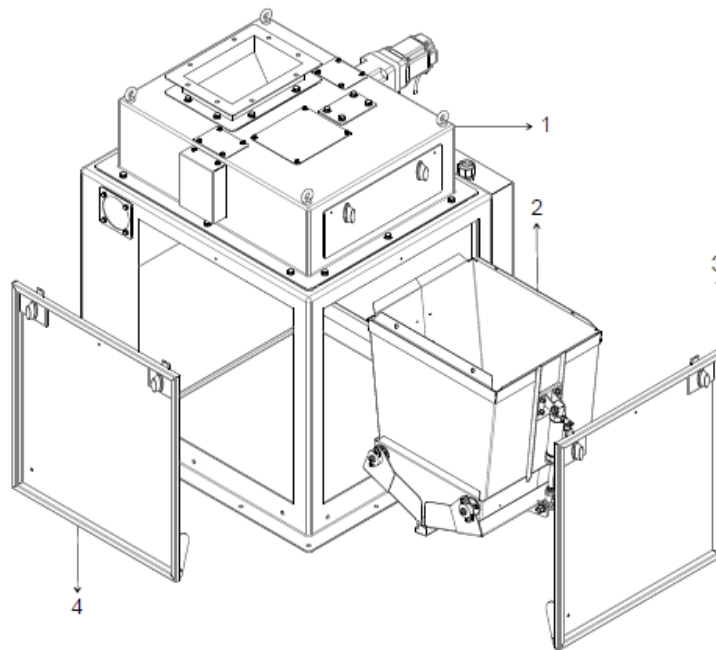

This product is designed to prevent sensor damage during transportation. The method of disassembling and inverting the metering bucket inside the scale frame is adopted. After receiving the product, it is necessary to install the metering bucket. The illustration shows a single scale, and a double scale means two buckets.

The metering bucket of this product adopts a fast loading and unloading design. A single person can complete the installation of the metering bucket in 10 minutes.

As shown in the figure:

1. Open the scale frame door panel.
2. Loosen the retaining bolts of the metering bucket.
3. Take the metering bucket out of the scale frame and turn it upside down (as shown in the figure).
4. Insert the metering bucket horizontally into the metering bucket bracket (as shown by the arrow in the figure).

Note that the beveled edge of the metering bucket should catch the beveled edge of the bracket.

Take care to prevent the discharge door from opening.

5. After inserting into place, align the hole locations and lock the four eyebolts.
6. Connect the discharge cylinder air pipe.
7. Install the door panel.

3.4.4 Requirements for equipment installation and maintenance

1. The operator must accept the company's skill training and safety education, and hold a work permit.
2. The personnel responsible for operating the machine must read and fully understand the operation manual.
3. Operators must have short hair or long hair up, clothing and shoes and hats should be easy to work. Wear a safety helmet and insulating shoes during testing or maintenance.
4. The operator must strictly follow the procedures and steps stipulated in the user manual.
5. Before lubrication, mechanical adjustment, maintenance and repair of the equipment, the power supply shall be cut off, the air source shall be closed, the residual pressure in the pneumatic pipeline shall be released, and the warning signs shall be hung at the electric control cabinet, the power switch and the air source valve.
6. The maintenance and repair of the air pressure system must be carried out under the condition of cutting off the power supply and releasing the pressure completely.
7. The production line shall not be operated until all safety protection facilities are in place.
8. After the device is powered on, do not touch the moving parts of the device.

9. When the production line is in operation, do not enter dangerous areas or cross the production line.

10. Do not modify the setting parameters of wiring in the control cabinet, motherboard program and driver.

11. The tool installation is reliable and safe, and the operator understands and understands all the safety requirements of the tool.

4. Product size

Product size unit: mm

4.1 AF-25KII-103B Overall dimensions

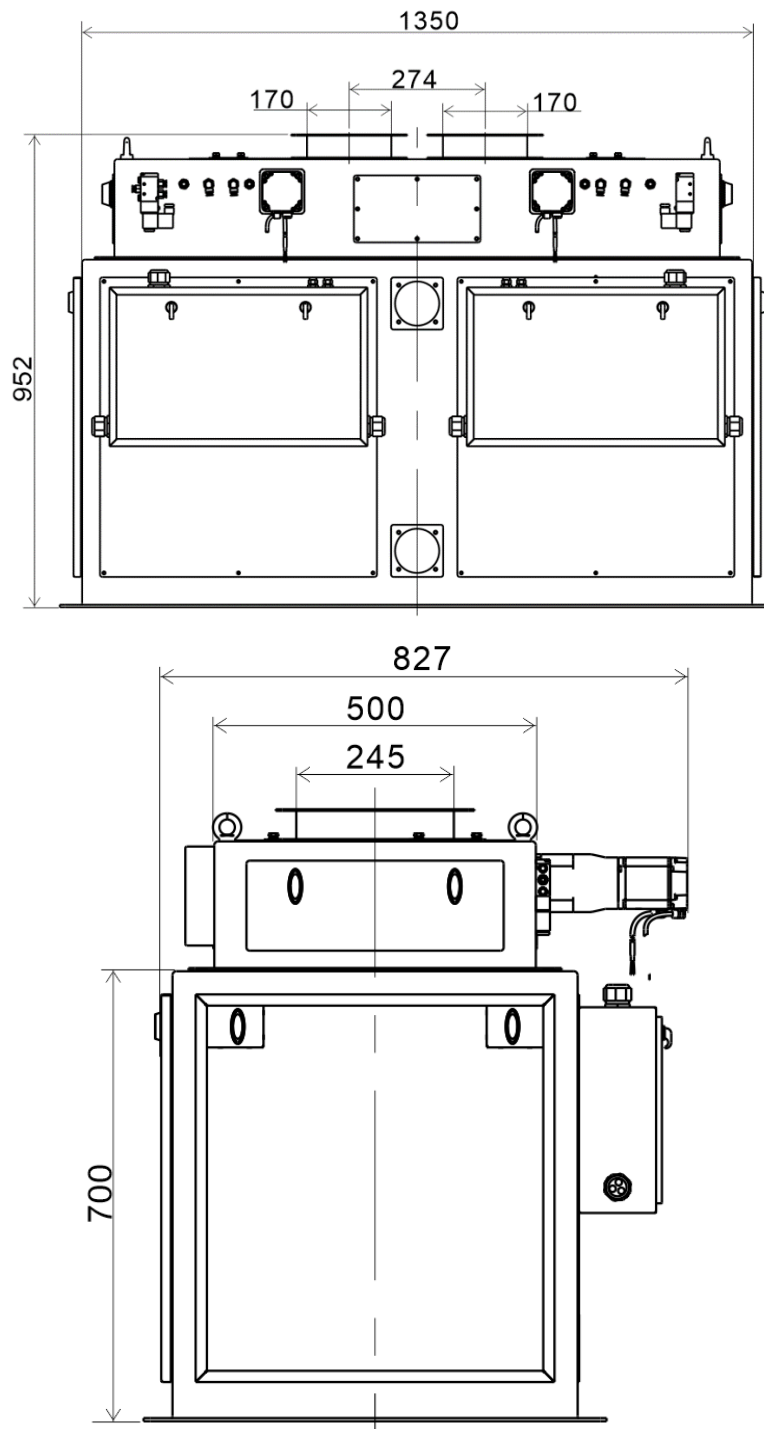

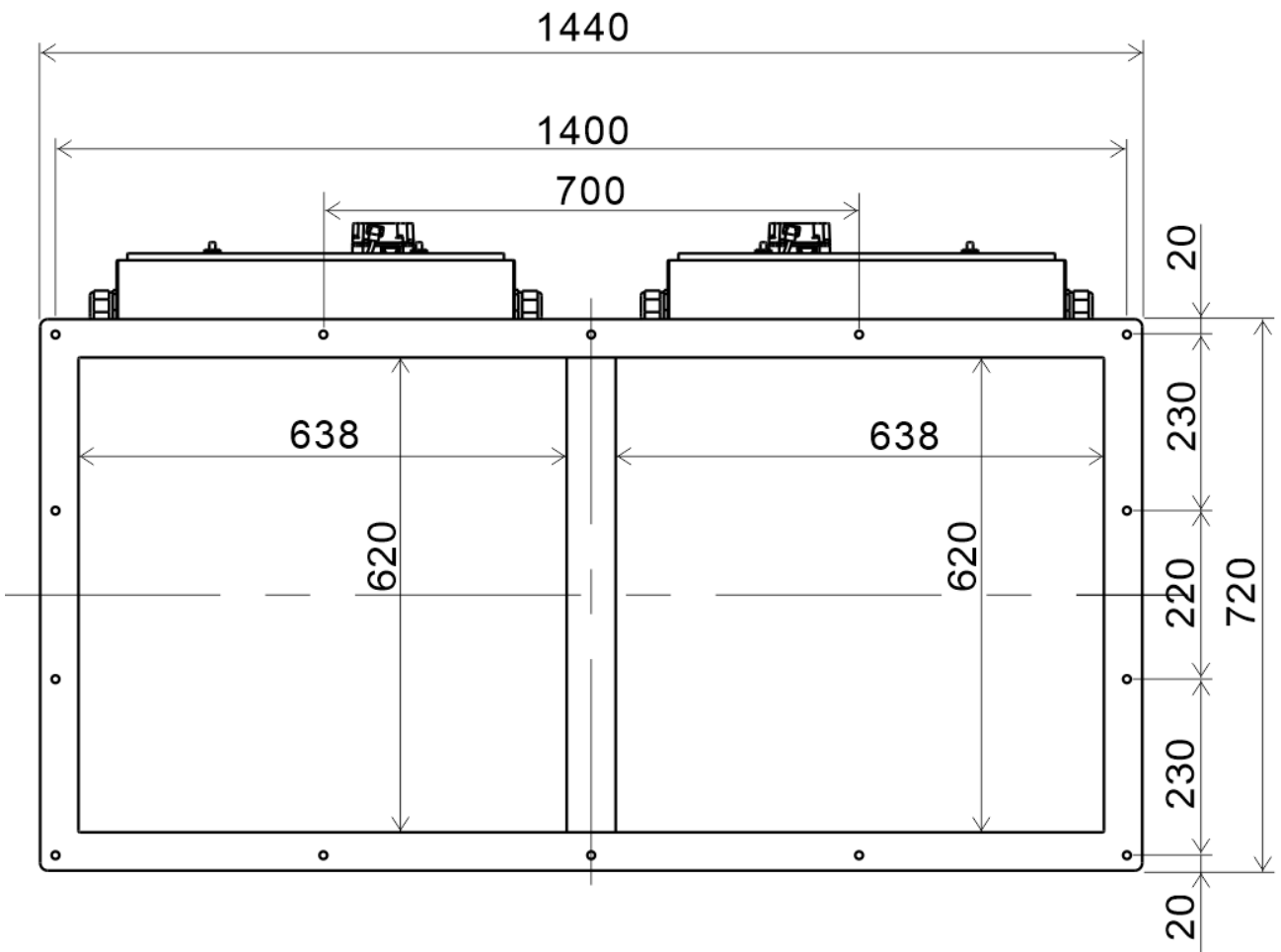
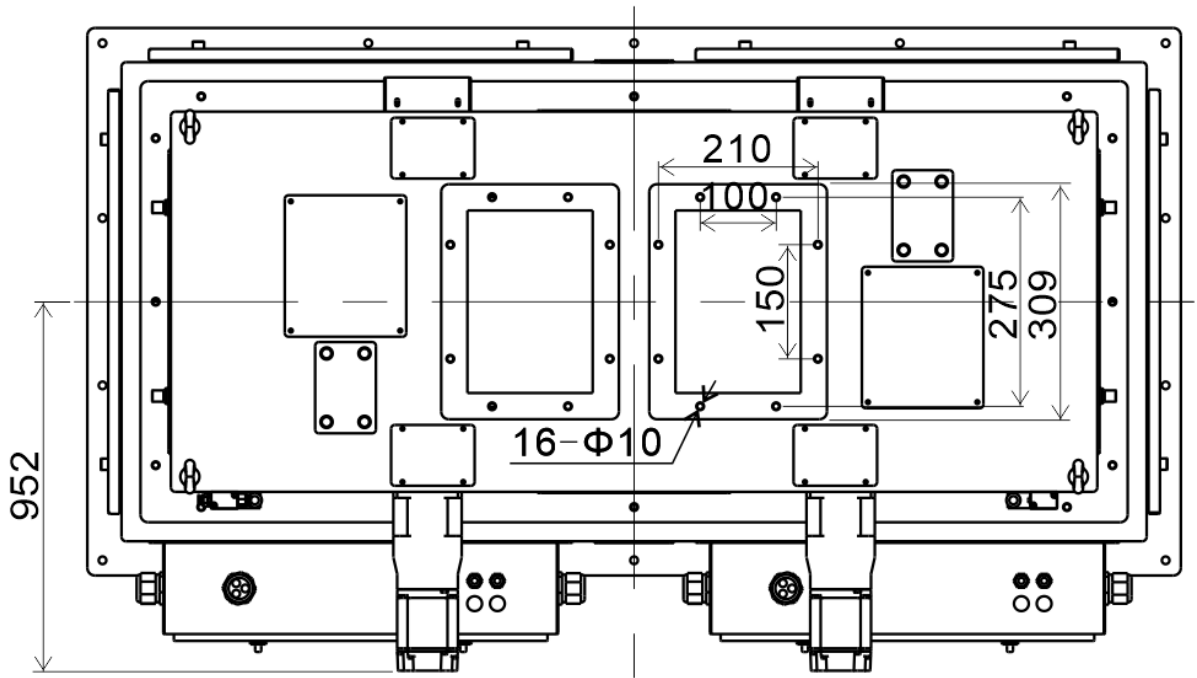

4.2 AF-50KII-103B Overall dimensions

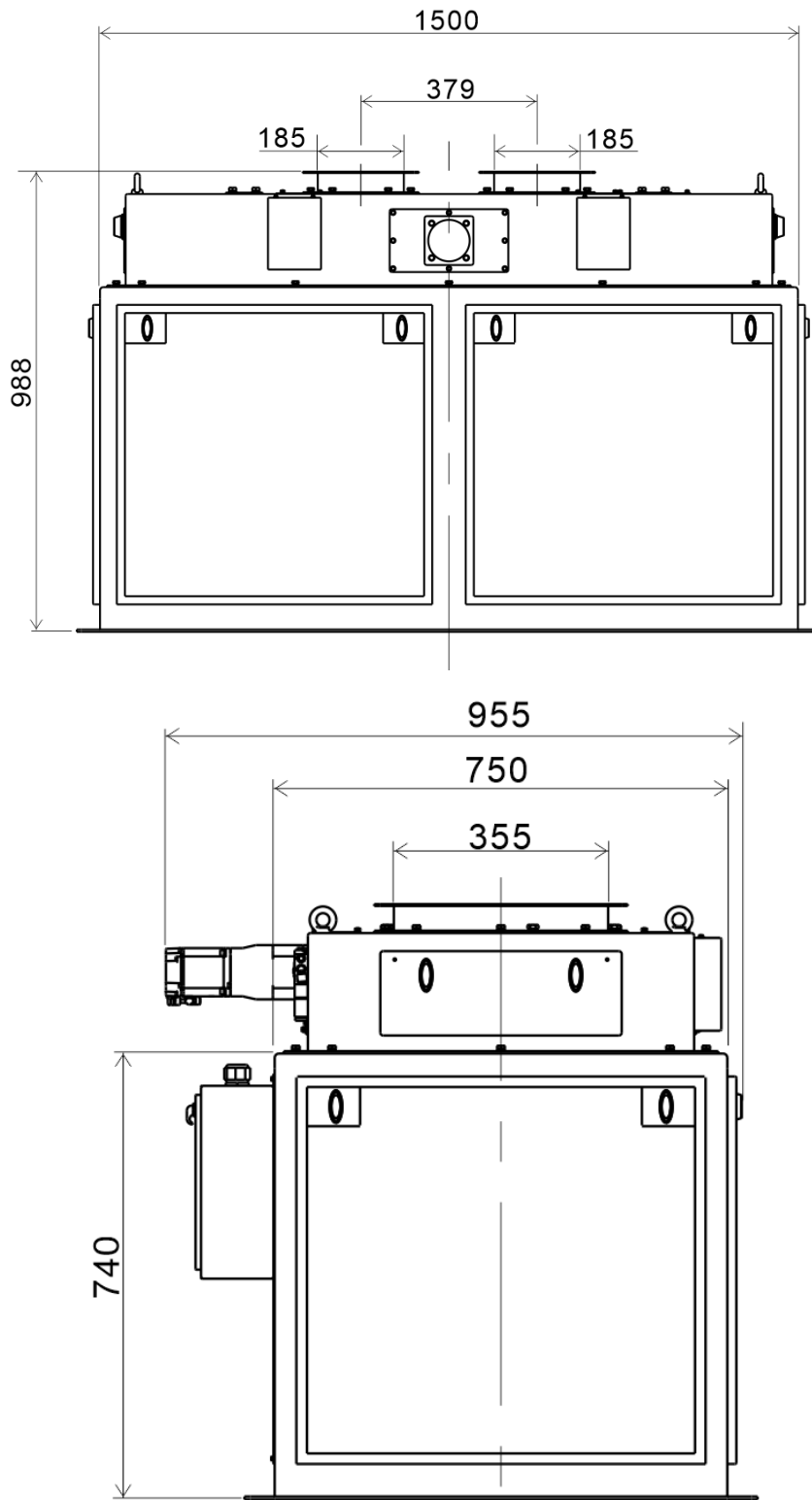

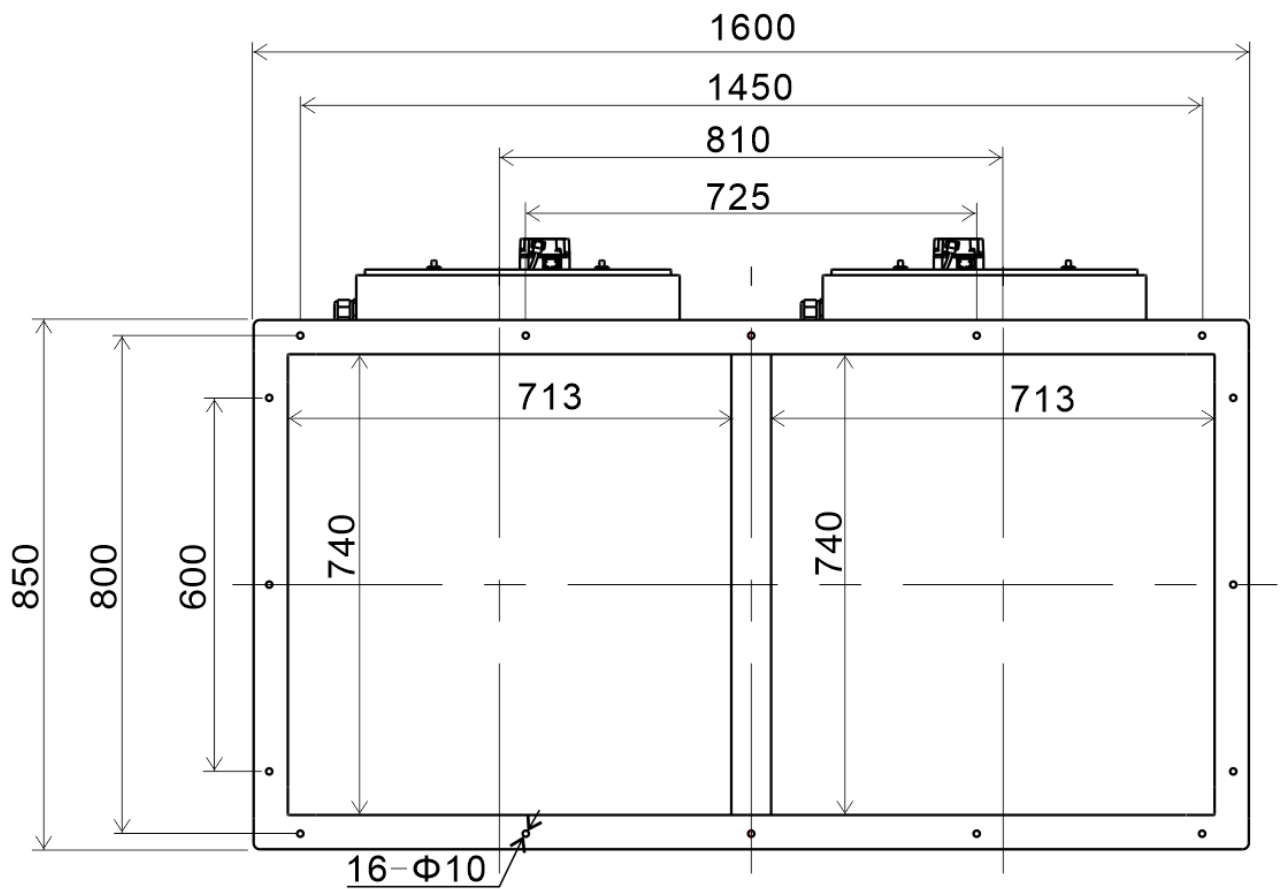
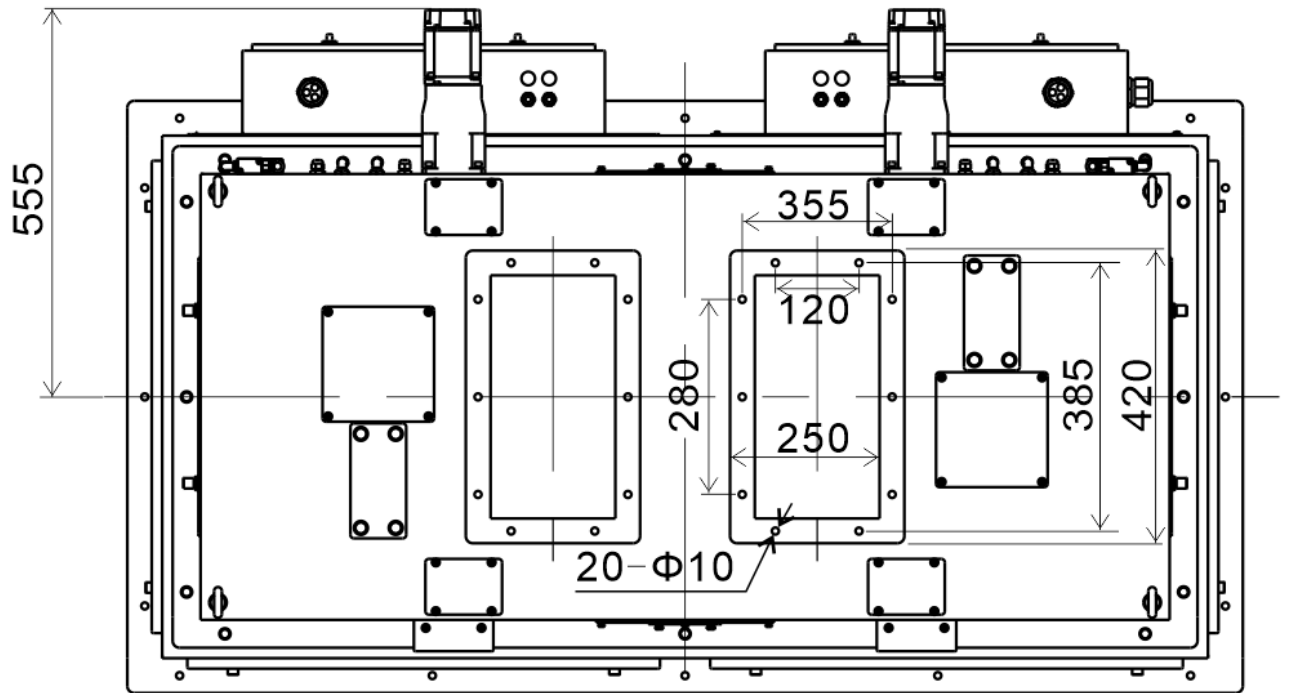

5. Electrical connections

5.1 Air supply connection

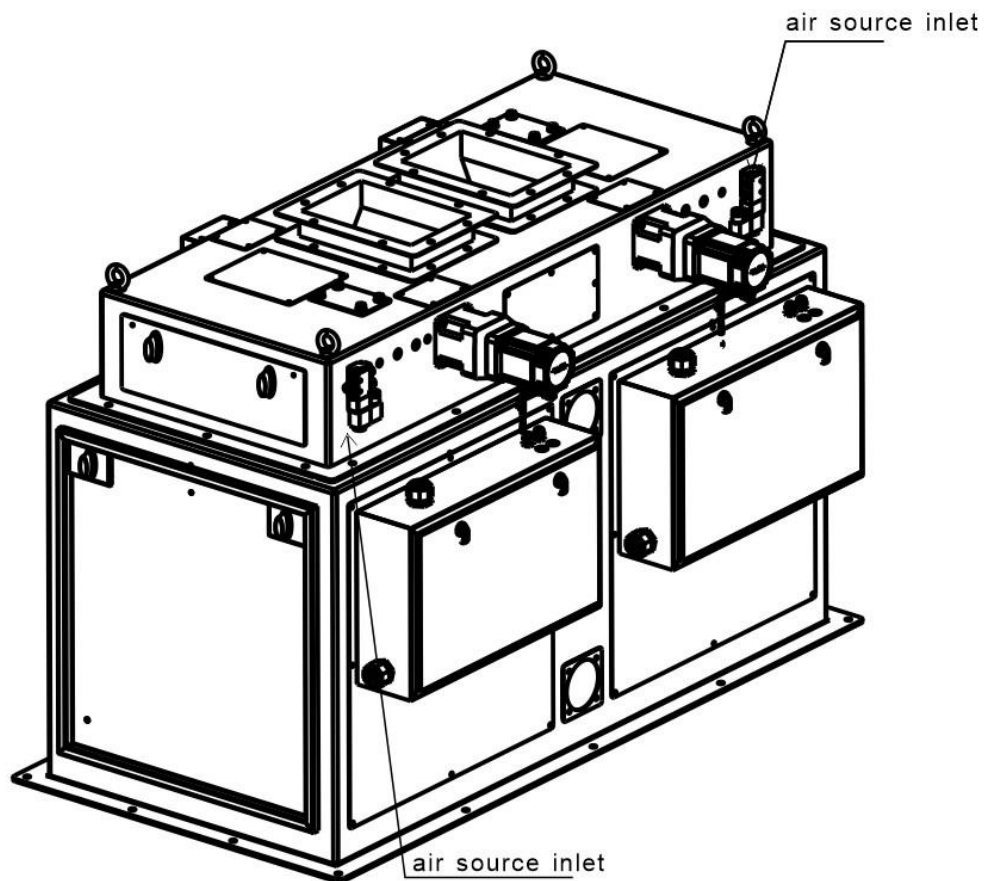

Air source inlet $\phi 6$ air pipe, air source standard: 0.4~ 0.6mpa 2m³/h

5.2 Electrical connections

Insert the single-wire 220V power plug into the onsite power socket.

The internal layout of the electric control box is shown as follows:

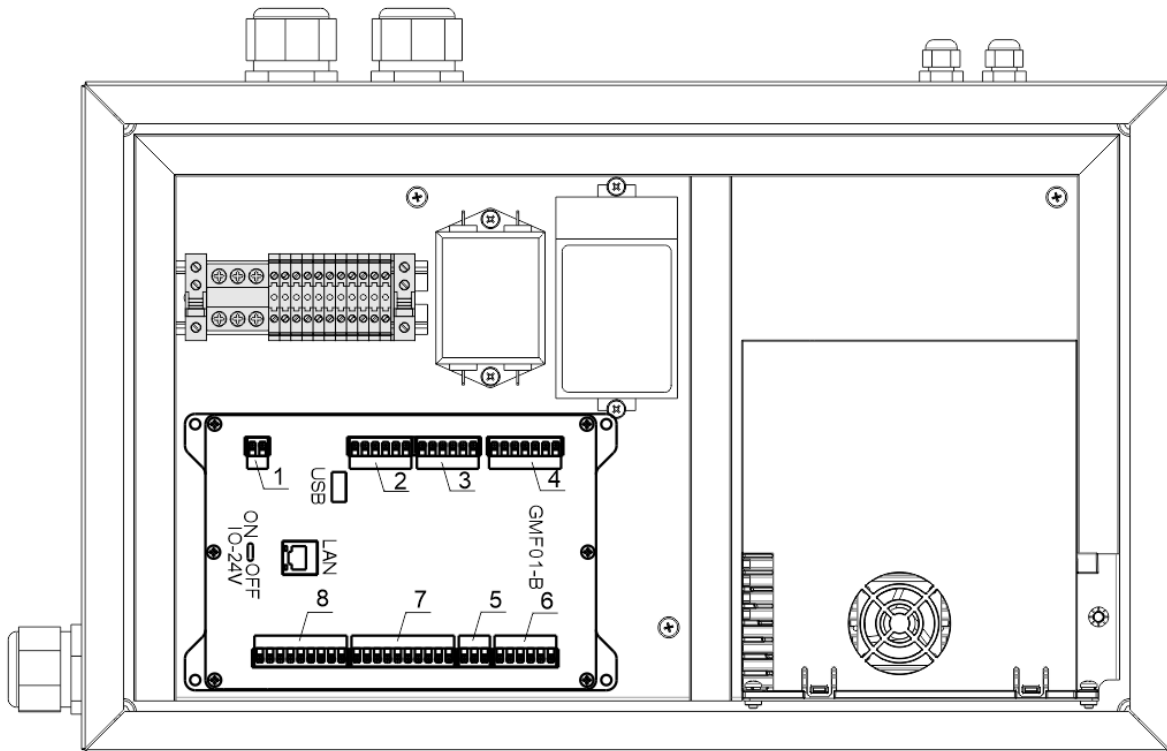

The PCB interfaces are defined as follows:

5.2.1 External interface definition

- 1: Power cord port, 24V power port of the instrument (24V+, 24V -).
- 2: Motor control port 1, (M1_24V+: 24V positive, M1_24V -: 24V negative, PU1: pulse, DR1: direction, ZT1_1: origin detection input, ZT1_2: feeding door opening limit), can also be used as a common IO port, currently used for feeding motor control.
- 3: Motor control port 2, currently used as a common IO port.
- 4: Sensor wire ports, sensor wiring ports (SHLD, EX+, EX -, SN+, SN -, SIG+, SIG -).
- 5: RS485 serial communication port, serial port 1 (A1, B1, GND1) is generally used for local HMI communication.
- 6: Two RS485 serial communication ports, serial port 2 (A2, B2, GND2) and serial port 3 (A3, B3, GND3), can be used for upper computer communication, and both support Modbus communication.
- 7: Input ports, 8 customizable switching input interfaces (IN1, IN2, IN3, IN4, IN5, IN6, IN7, IN8), valid for low levels, and the definition of each port can be selected by yourself.

8: Output ports: 8 customizable switching output interfaces (OUT1, OUT 2, OUT 3, OUT 4, OUT 5, OUT 6, OUT 7, OUT 8). The definition of each port can be selected by yourself.

USB: USB interface can be used for various data import and export.

LAN: The network interface can be used for networking and data transmission.

IO-24V: Internal use.

5.2.2 Switching value interface wiring description

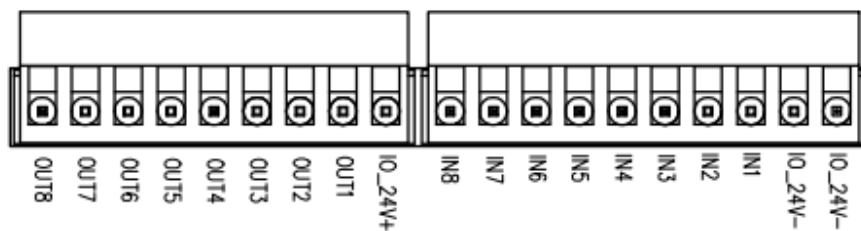

Switching value interface diagram

The switching value adopts photoelectric isolation method. If users need to use a switching interface, they need to provide and connect to a DC24V power supply. Switching value input is valid at low level; The output adopts the transistor collector open circuit output mode, and each drive current can reach 500mA.

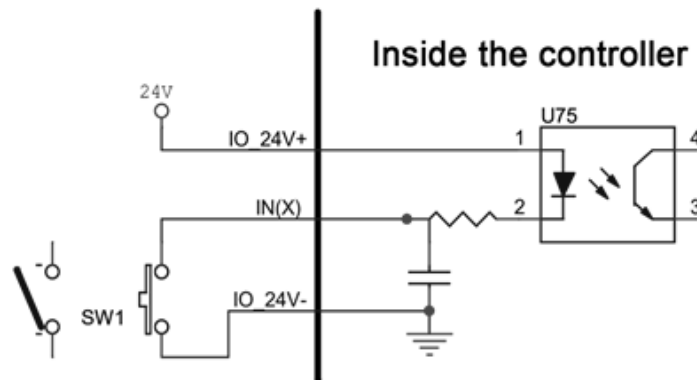

Schematic diagram of input interface

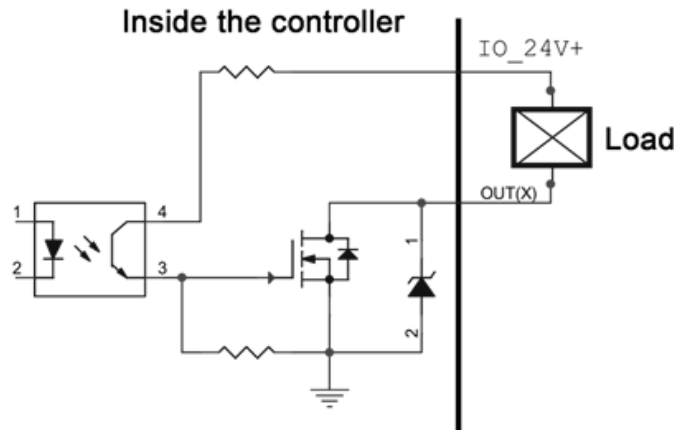

Schematic diagram of output interface

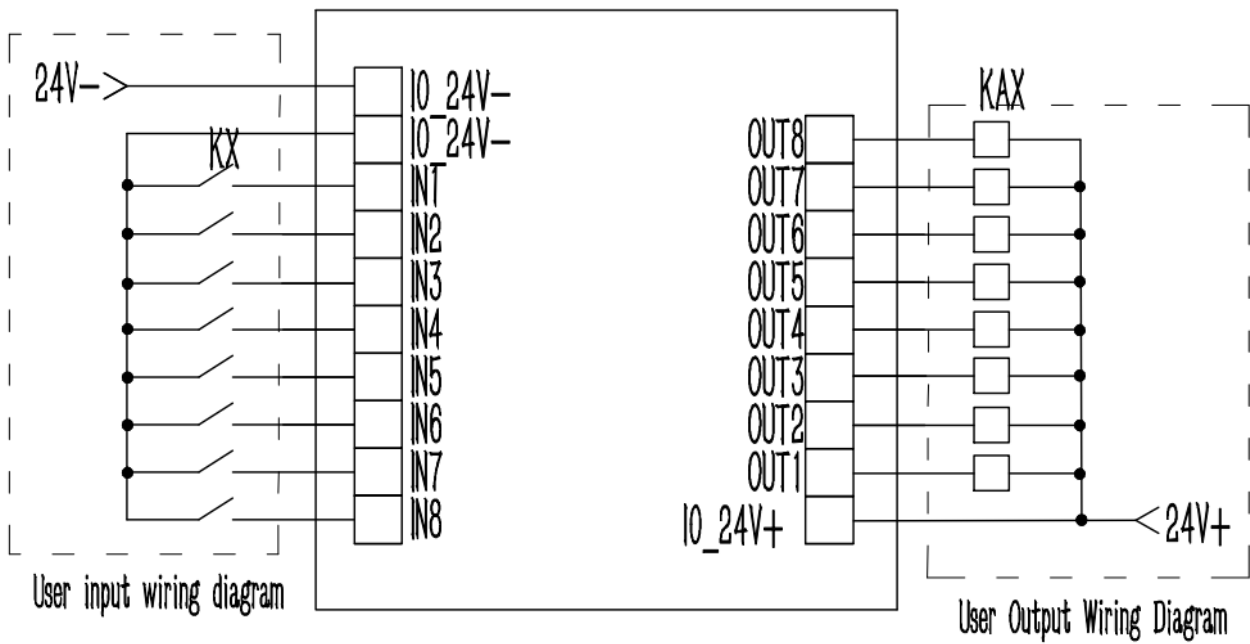

Wiring diagram of user input and output ports

6. The Modbus address table

In [Communication Parameters], serial port communication is usually modbus-RTU. When the communication parameters are consistent with the Settings of the upper computer, modbus-RTU protocol is used for communication.

The PLC addresses	Function address	meaning	instructions	
The following is a read-only register (function code 0x03)				
Instrument status parameter				
40001	00000	The current weight	4 bytes, signed number	
40002	00001			
40003	00002	Instrument condition 1	position	instructions
			. 00	The AD collection module is abnormal
			. 01	Memory failure
			. 02	keep
			. 03	Abnormal sensor signal
			. 04	The weight of overflow
			. 05	Weight is stable
			. 06	zero
			. 07	Minus sign
			. 08	Millivolts are stable
	. 09 ~. 15	keep		
40004	00003	Instrument status 2	. 00	run
			. 01	Before loading
			. 02	Quickly add
			. 03	To add

			. 04	Slowly add
			. 05	Constant value
			. 06	Super poor
			. 07	Owe less
			. 08	Call the police
			. 09	Waiting for the clip bag
			. 10	Clip bag
			. 11	discharge
			. 12	Charging to allow
			. 13	Discharge allow
			. 14	jam
			. 15	keep
40005	00004	Instrument status 3	. 00	keep
			. 01	keep
			. 02	Complete one package (duration 1S)
			. 03 ~. 15	keep

40006	00005	Alarm queue 1	<ul style="list-style-type: none"> 00: No alarm 01: Batch to complete 02: Clear out of range (2s) 03: Unstable at zero clearing (2s) 04: Target value 0 cannot start (2s) 05: Pause the gap 06: keep 07: Disable zero clearing operation in operation (2s) 08: Overage and underage alarm 09: keep 10: keep 11: Discharge fault 12: Discharging timeout 13: Feeding motor running time out 14: Discharging motor running timeout 15: Unable to run during emergency stop (2S) 16: Zero clearance failure (zero clearance before feeding operation) 17: Charging a timeout 18: Steady value judgment timeout (steady value judgment method) 19: Feeding motor alarm 20: Discharging motor alarm 99: Software authentication failure
40007	00006	Alarm queue 2	

40008	00007	Alarm queue 3	1. When there are multiple alarms at the same time, press "Happening" Up to three alarms are displayed at the same time.
40009	00008	The default package number	Initial value: 0. The value ranges from 0 to 99999
40010	00009		
40011	00010	Number of preset packets remaining	Initial value: 0. The value ranges from 0 to 99999
40012	00011		
40013	00012	Current gross weight	Unlike 40001, this register is not subject to constant weight retention Switch control, when the switch is on, even during unloading, also Return to actual weight
40014	00013		
40015	00014	The reserved	
...	...		
40030	00029		
40031	00030	Year (readable and writable)	Scope: 2000 ~ 2099
40032	00031	Month (readable and writable)	Scope: 1 ~ 12
40033	00032	Day (readable and writable)	Scope: 1 ~ 31
40034	00033	week	Scope: 1 ~ 7
40035	00034	Hours (readable and writable)	Scope: 0 ~ 23
40036	00035	Points (readable and writable)	Scope: 0 ~ 59
40037	00036	Second (readable and writable)	Scope: 0 ~ 59
40038	00037	The reserved	
...	...		

40050	00049		
40051	00050	Package formula number	Formula number and target value when "packing result weight" is generated,
40052	00051	Package target value	Manual unloading, also do a result save, but the formula number is equal to 0
40053	00052		
40054	00053	Packing result weight	Weight unit is system unit, updated at the end of unloading
40055	00054		
40056	00055	Actual packing time	Update at the end of unloading, in milliseconds
40057	00056	(including waiting time)	
40058	00057	Theoretical packing time	
40059	00058	(Not including waiting time)	
40060	00059	Delay before feeding	
40061	00060	(including clear Zero additional delay)	
40062	00061	Quickly add time	
40063	00062		
40064	00063	To add time	
40065	00064		
40066	00065	Slowly add time	
40067	00066		
40068	00067	Fixed time (slow plus end to	
40069	00068	Discharging start)	
40070	00069	Wait for bag clamping	
40071	00070	(unloading allowed) time	
40072	00071	Discharging time	

40073	00072		
40074	00073	Actual packing speed	Update at the end of unloading, unit: BPH
40075	00074		
40076	00075	Theoretical packing speed	
40077	00076		
40078	00077	deviation	
40079	00078		
40080	00079	Number of speed sampling packets Nspeed (Readable and write)	Initial value: 6. Range: 6 to 12
40081	00080	Generation date of subcontracting data	Decimal 8-digit month day, such as: 20160111 (2016/01/11)
40082	00081		
40083	00082	Generation time of packet data	Decimal 6-bit time, such as 160552 (16:05:52)
40084	00083		
40051~40084: It is possible to monitor the positive jump of the "once packaged" (4005.02) bit variable, and run the bit variable (4004.00) equal to 1 to identify register updates in this region			
The following contents are readable and writable (Write a single register function code is 0x06, write multiple registers function code is 0x10, read function code is 0x03)			
Calibration parameters			
40101	00100	The zero calibration	Write 1 to mark zero; read returns 0
40102	00101		
40103	00102	There is weight gain calibration (Input weight)	The value ranges from 0 to 999999, expressed in grams
40104	00103		

40105	00104	Material gain calibration (note	Input 1 to record the gain AD code, and read returns 0	
40106	00105	Record current AD code)		
40107	00106	Material gain calibration	The value ranges from 0 to 999999, expressed in grams	
40108	00107	(Input weight)		
40109	00108	Absolute Millivolt (read only)	Default 3 decimal points, unit: millivolt	
40110	00109		If the value is 12345, it means 12.345	
40111	00110	Gain millivolts (read only)	Default 3 decimal points, unit: millivolt	
40112	00111		If the value is 12345, it means 12.345	
40113	00112	Calibration result information (read only)	The results of instructions	
			0	There is no information
			1	Calibration is successful
			2	The current sensor voltage is unstable
			3	Input weight is not reasonable
			4	The current sensor voltage is too high
			5	The current sensor voltage is too low
			6	Excessive calibration resolution
			The alarm message will be automatically eliminated after 2 seconds. Before elimination, no	
Allow to calibrate again				
The basic parameters				
40201	00200	unit	Initial value: 1,0: g;1 kg;2: t;3: b	
40202	00201	The decimal point	Initial value: 3. The value ranges from 0 to 4	

40203	00202	Dividing the value	Initial value: 1. Range: 1, 2, 5, 10, 20, 50
40204	00203	Maximum range	If the device model is AF-5K, the initial value is 10000
40205	00204		If the device model is AF-10K, the initial value is 20000 The value ranges from 1 to 999999, expressed in grams
40206	00205	OFL indicates the type	Initial values: 0, 0:[maximum range + 9D] display OFL; 1:[maximum range *120%] to display OFL; 2:[maximum range *150%] to display OFL
40207	00206	Scale range mode	Initial values: 0, 0, 5 k; 1:25K;2:50K;3:10K;4: the reserved
40208	00207	Automatic zero clearance interval	Initial value: 80. The value ranges from 0 to 9999, expressed in milliseconds
40209	00208	Start additional clearance times	Initial value: 2. The value ranges from 0 to 9
40210	00209	Additional zero clearance time	Initial value: 1000. The value ranges from 0 to 9999, in milliseconds
40211	00210	Handling method of failure to clear data	Initial values: 0, 0: only alarm, lasts 1S, give up zero clearance this time, clear again next time; 1: only alarm, lasts 1S, give up zero clearance this time, clear again next time, connect Unable to reset three times, return to stop state!Continue to report to the police 2: alarm, but continue to wait for stability, once stable, eliminate the alarm, Automatically continue to run; 3: alarm, immediately return to stop state.
40212	00211	Reset the scope	Initial value: 10. Range: 0 to 99, unit: %

40213	00212	Sentenced to stabilizing range	Initial value: 5. Range: 0 to 99, unit: D
40214	00213	Sentenced to stabilizing time	Initial value: 300. The value ranges from 100 to 9999, expressed in milliseconds
40215	00214	Zero tracking range	Initial value: 3. Range: 0 to 9, unit: D
40216	00215	Zero tracking time	Initial value: 2000. The value ranges from 0 to 9999, expressed in milliseconds
40217	00216	Stop the AD filter series	Initial value: 9. The value ranges from 0 to 9
40218	00217	Add AD filter series	Initial value: 2. The value ranges from 0 to 9
40219	00218	Fixed value AD filter series	Initial value: 5. The value ranges from 0 to 9
40220	00219	Discharging AD filter series	Initial value: 2. The value ranges from 0 to 9
40221	00220	Power-on automatic reset switch	Initial value: 0. Range: 0 to 1
40222	00221	Manual unloading cumulative switch	Initial value: 0. Range: 0 to 1
40223	00222	Constant weight hold switch	Initial value: 1 the value ranges from 0 to 1
40224	00223	Unloading mechanism mode	Initial value: 0,0: pneumatic, 1: unidirectional general motor, 2: common motor bidirectional, 3: one-way stepping motor
40225	00224	Unloading working mode	0: timing mode, discharging signal output continuous discharging time (formula Parameter) is turned off. Discharging abnormal after discharging Judge; 1: Judge zero zone mode, signal output, until the weight is below zero zone Value, and then start unloading delay time, when the time is up, close unloading

			After entering the discharging delay, there is no need to distinguish the weight.
40226	00225	Discharge delay	Initial value: 200. The value ranges from 0 to 9999, expressed in milliseconds
40227	00226	Discharging timeout time	Initial value: 2000. The value ranges from 0 to 20000, expressed in milliseconds
40228	00227	Loose bag model	0: automatically loosens the bag after unloading. 1: automatically loosens the bag after unloading Manual loose bag
40229	00228	Discriminant mode of feeding allowance	0: judge only when start feeding, no longer judge during feeding; 1: Keep judging during feeding.
40230	00229	Allowable discharging discriminant mode	0: judge only when starting unloading, no longer judge in unloading process; 1: Keep judging during unloading.
40231	00230	Over range feeding protection	Initial value: 1, 0: close; 1: on. When on, from the calibration zero (plus zero clearing) Cleared part), the weight is greater than or equal to specification *1.2, then judged OFL, whether or not the maximum range is exceeded. Preventing zero clearing will be large After the weight is cleared to 0, the weight is small, but it is Overcharge. at the same time, adjust the settable value of the clearing range from 99% The whole of 20%
User preferences			
40301	00300	Material no.	Initial value: 1. The value ranges from 0 to 10

40302	00301	The formula,	Initial value: 1. The value ranges from 0 to 20
40303	00302	The target	Initial value: 0. The value ranges from 0 to 999999, expressed in grams
40304	00303		
40305	00304	Step up quickly	Initial value: 0, range: 0 to maximum range, unit: gram
40306	00305		
40307	00306	Add the lead quantity	Initial value: 0, range: 0 to maximum range, unit: gram
40308	00307		
40309	00308	Slow down and advance	Initial value: 0, range: 0 to maximum range, unit: gram
40310	00309		
40311	00310	Zero value	Initial value: 0, range: 0 to maximum range, unit: gram
40312	00311		
40313	00312	Discharging time	Initial value: 300. The value ranges from 0 to 99999, expressed in milliseconds
40314	00313		
40315	00314	Delay before feeding	Initial value: 0. The value ranges from 0 to 99999, expressed in milliseconds
40316	00315		
40317	00316	Fixed hold time	Initial value: 900. The value ranges from 0 to 99999, in milliseconds
40318	00317		
40319	00318	Switch for detecting overcurrent and undercurrent	Initial value: 0. Range: 0 to 1
40320	00319	Ultra difference	Updated at the end of unloading, range: 0~maximum range, unit: g
40321	00320		
40322	00321	Owing to difference	Updated at the end of unloading, range: 0~maximum range, unit: g
40323	00322		
40324	00323	Overtime and undertime alarm	Initial value: 0. The value ranges from 0 to 99999, expressed in milliseconds
40325	00324		

40326	00325	Pause switch over and under difference	Initial value: 0. Range: 0 to 1
40327	00326	Combined mode (read only)	Initial value: 1, Read-only 1 or 2:1 Uncombined mode 2 Combined mode
40328	00327	Feeding level (read only)	Initial value: Automatically determined according to the target value Feeding series,2: two-stage feeding;3: three-stage feeding. The controller will Automatic selection according to the range is two - stage feed or three - stage feed Material.[grade 2, fast + slow add, add lead and add open [grade 3, add + add + slow add, but add or add quickly If the lead is set to 0 or the opening is set to 0, it still does not go fast plus or medium Add]
40329	00328	The opening is configured independently	Fixed to 1 and cannot be modified
40330	00329	The formula is quickly widened	Initial value: 8000. Range: 0 to maximum openness
40331	00330	Add the opening in this formula	Initial value: 5000. Range: 1 to the maximum openness
40332	00331	This recipe is slow in opening	Initial value: 1800, range: 2~ maximum openness
40333	00332	Discharge opening	Initial value: 5500, range: 0~ 20000
40334	00333	Slow addition and feeding function switch	Initial value: 0, range: 0~ 1
40335	00334	Slow feeding single time	Initial value: 0.4, range: 0.1~ 9.999S

40336	00335	Slow addition of feeding	Initial value: 1, range: 1~ 9	
40337	00336	Breaking weight: Cutting off the slow opening of the flow	Initial value: 1000, range: 0~ 999999	
40338	00337			
40339	00338	Slow flow break and conservative opening	Initial value: 2000, range: 2000~ 30000	
40340	00339	Single scale combination counting	Initial value: 0, range: 0~ 99	
40341	00340	Delay time for unloading	Initial value: 1000, range: 0~ 9999	
Switching parameter				
40401	00400	Start/end the switch test	Write 1 to start the switching test; Write 0 to end the switch measurement try	
40402	00401	Input switching test (Read Only)	From low to high each represents an input state	
40403	00402	Output switching test	Each digit represents an output state from low to high	
40404	00403	IN1	The initial value	instructions
			1	Enter a list of definitions:
40405	00404	IN2	2	I00: No definition
40406	00405	IN3	5	I01: start
40407	00406	IN4	6	I02: stop
40408	00407	(1-ZT1)	4	I03: stop
40409	00408	(1-ZT2)	23	I04: Feeding stepper motor origin (close the door to
40410	00409	(2-ZT1)	0	A level)
40411	00410	(2-ZT2)	0	I05: Feeding allowed

40412	00411	IN5	0	I06: Unloading allowed
40413	00412	IN6	0	I07: Clear alarm
40414	00413	IN7	0	I08: keep
40415	00414	IN8	0	I09: Open/close unloading door [originally manual unloading Function, switch discharging output state] I10: Manual unloading I11: Manual slow add I12: Manually add I13: Manual fast add [by fast open open The door] I14: Manual cleaning [open according to the maximum opening The door] I15: Start/stop (double edge: effective edge, Start;Invalid edge, stop) I16: Start/emergency stop (double edge) I17: Manual unloading (double edge) I18: Manual slow adding (double edge) I19: Manual adding (double edge) I20: Manual quick add (double edge) I21: Manual cleaning (double edge) I22: reset I23: Emergency stop [level](valid, no

				Start allowed, manual feeding not allowed, not allowed Manual unloading is allowed) I24: feeding stepping motor limit point. I25: Unloading stepping motor origin. I26: limit point of unloading stepping motor. I27: jam I28: Servo motor alarm I29: Double scale interlock input I29: AB interlock input I30: Unloading servo alarm
40416	00415	OUT1	1	Output definition list:
40417	00416	OUT2	4	O00: No definition
40418	00417	OUT3	5	Run O01:
40419	00418	OUT4	6	O02: Refueling request
40420	00419	OUT5	7	O03: Feeding stepper motor direction [PW available
40421	00420	OUT6	8	The signal is set to feed PWM]
40422	00421	OUT7[DR1]	3	O04: quick to add
40423	00422	OUT8[DR2]	8	I add O05:
40424	00423	OUT9[PWM1]	0	O06: slow
40425	00424	OUT10[PWM2]	0	O07: fixed value O08: unloading L O09: over difference O10: alarm 11: clip bag

			<p>O12: Preset number of packets completed</p> <p>O13: Once packing is completed (unloading is completed After output 1s clock)</p> <p>O14: stop</p> <p>O15 unloading step motor direction</p> <p>O16 Discharging motor running/forward</p> <p>O17 discharging motor reverses</p> <p>O18 feeding PWM[only AVAILABLE for OUT7/OUT8]</p> <p>O19 Discharging PWM[only available at OUT7/OUT8]</p> <p>O20: Feeding servo alarm output</p> <p>O21: Fixed value completion</p> <p>O22: AB interlock output</p> <p>O23: Unloading servo alarm output</p> <p>O24: Unloading status output</p>
40426	00425	PWM1 function	Initial value, 1,0: off;1: charging PWM;2: unloading PWM
40427	00426	PWM2 function	Initial value, 0,0: close;1: charging PWM;2: unloading PWM
40428	00427	Start	Write: 1, read: 1: running status, 0: stopped status
40429	00428	scram	Write: 1, read: 1: running status, 0: stopped status
40430	00429	stop	Write: 1, read: 1: Stop signal has been entered (this time packing The process will stop after the end), 0: the stop signal is not entered

40431	00430	reset	Write: 1, read: 1: weight is 0, 0: weight is not 0
40432	00431	Remove alarm	Write: 1, read: 1: no alarm, 0: alarm
40433	00432	Choose the formula	Write: 1, read: 0
40434	00433	Loose bag	Write: 1, read: 1: packed, 0: not packed.
40435	00434	Open/close discharge door	Write: 1, switch unloading door status, valid -> invalid, invalid -> Yes Read: 1: discharging effective, 0: discharging invalid
40436	00435	Slowly add manually	Write: 1, read: 1: slow add effective, 0: slow add invalid.
40437	00436	Manually add	Write: 1, read: 1: add valid, 0: add invalid.
40438	00437	Quickly add manually	Write: 1, read: 1: fast add is valid, 0: fast add is invalid
40439	00438	Manually removing mixture	Write: 1, read: 1: cleaning effective, 0: cleaning ineffective
40440	00439	Manual maximum opening speed	Write: 1, read: 1: fast add is valid, 0: fast add is invalid
40441	00440	Automatic feeding once (fixed value junction Stop after bundle)	Write: 1, read: 1: automatic feeding, 0: not automatic feeding material
40442	00441	Emergency stop	Write :0/1, exit/enter emergency stop lock Read :1: emergency stop, 0: no emergency stop
40443	00442	Manual discharging once	Write: 1, read: 1: discharging, 0: discharging invalid
40444	00443	Allowed to add	Read/write 1, grant valid, read/write 0, grant invalid
40445	00444	Allow unloading	Read/write 1, enable/disable, read/write 0, enable/disable
40446	00445	OUT7	Same as OUT1-OUT6

40447	00446	OUT8	
Communication parameters			
40501	00500	Serial port 1 Slave (read only)	Initial value, 1. Range: 1 to 99
40502	00501	Serial port 1 communication protocol (only Read)	Initial value: 0,0: Modbus-RTU, 1: Modbus- ASCII
40503	00502	Serial port 1 Baud rate (read only)	Initial value, 3, 0:9600, 1:19200, 2:38400, 3:57,600, 4:115,200
40504	00503	Serial port 1 data format (only Read)	Initial value, 1,0:18N2, 1:18e1, 2:18o1, 3: 18N1
40505	00504	Serial port 1Modbus double word mail Memory order (read only)	Initial value, 0,0: ABCD, 1: CDAB
40506	00505	Serial port 2 Slave machine number	Initial value, 1. Range: 1 to 99
40507	00506	Serial port 2 communication protocol	Initial value: 0,0: Modbus-RTU, 1: Modbus- ASCII
40508	00507	Serial port 2 baud rate	Initial value, 3, 0:9600, 1:19200, 2: 38400, 3:57,600, 4:115,200
40509	00508	Serial port 2 data format	Initial value, 1,0:18N2, 1:18 E1, 2: 18O1, 3:18N1
40510	00509	Serial port 2Modbus High Low Word Order	Initial value, 0,0: ABCD, 1: CDAB
40511	00510	Serial port 3 slave number	Initial value, 1. Range: 1 to 99

40512	00511	Serial port 3 communication protocol	Initial value: 0,0: Modbus-RTU, 1: Modbus- ASCII
40513	00512	Serial port 3 baud rate	Initial value, 3, 0:9600, 1:19200, 2: 38400, 3:57,600, 4:115,200
40514	00513	Serial port 3 data format	Initial value, 1,0:18N2, 1:18 E1, 2: 18O1, 3:18N1
40515	00514	Serial port 3Modbus High Low Word Order	Initial value, 0,0: ABCD, 1: CDAB
40516	00515	Network port IP group 1	0~255
40517	00516	Network port IP group 2	0~255
40518	00517	Network port IP group 3	0~255
40519	00518	Network port IP group 4	0~255
40520	00519	Network port number	0~65535
40521	00520	Network interface communication protocol	0: Modbus-TCP/IP 1: Minicenter 2: Web
40522	00521	High and low byte order of network interface	0: AB-CD 1: CD-AB
40523	00522	MAC1	0~0xFF
40524	00523	MAC2	0~0xFF

40525	00524	MAC3	0~0xFF
40526	00525	MAC4	0~0xFF
40527	00526	MAC5	0~0xFF
40528	00527	MAC6	0~0xFF
System parameters			
40701	00700	Device model (ASCII code) Character) (read only)	'G'+ 'M'
40702	00701		'-' + 'F'
40703	00702		'0' + '1'
40704	00703		0
40705	00704		0
40706	00705		0
40707	00706		0
40708	00707		0
40709	00708		0
40710	00709		0
40711	00710	Version number (read Only)	4 bytes, unsigned number, such as converted decimal value to 123456, 12.34.56, range: 0 to 999999
40712	00711		
40713	00712	Compile date: year (read only)	2000 ~ 2099
40714	00713	Compile date: Month (read only)	1 ~ 12
40715	00714	Compile date: day (read only)	1 to 31
40716	00715	Compile date: time (read only)	0 ~ 23
40717	00716	Compile date: Fen (read only)	0 ~ 59

40718	00717	Compile date: seconds (read only)	0 ~ 59
40719	00718	Parameters of the reset	Write: 0 resets all (production use, including all the following additional also There are statistical data clearance, cumulative clearance, putter related parameters) (Super user) 1 Reset all (clients) including all below 2 Reset basic parameters 3 Reset calibration parameters 4 Reset user parameters 5 Reset peripheral parameters 6 Reset the adaptive parameters 7 Reset communication parameters 8 Reset Switch Value User-defined parameter 9 Reset adaptive statistics Read: 0
40720	00719	keep	
40721	00720	Enable/disable USB	1: USB is enabled. 0: USB is disabled
40722	00721	The USB device is connected (only Read)	0: the USB device is connected. 1: the USB device is not connected
40723	00722	USB mass storage device Connected (read Only)	0: The USB mass storage device is connected 1: The USB mass storage device is not connected
Adaptive correlation parameters			
40801	00800	Adaptive master switch	Initial value: 1 the value ranges from 0 to 1

40802	00801	Self - adaptive & automatic scale adjustment	Initial value: 1. The value ranges from 0 to 4
40803	00802	Positive error function switch	Initial value: 0. Range: 0 to 1
Cumulative data parameter			
41201	01200	Clear the total accumulated data	Write 1 to clear the total cumulative data and cumulative data of all formulations Write 2 Clear the total accumulated data Do not clear the formula accumulated data
41202	01201	Clear cumulative formula data	Write person 0 to clear all formula accumulations Write 1 to 20 to clear the accumulated data of formula 1 to 20
41203	01202	Total cumulative number of times	Maximum 9-digit Decimal number
41204	01203		
41205	01204	Total cumulative weight (upper 4 digits)	Maximum 13 bit Decimal number
41206	01205		
41207	01206		
41208	01207		
Dedicated address for quick plus fixed value prediction			
43001	03000	Quickly add forecast increments	Read-only, unit g
43002	03001	Weight at the time of forecasting	Read-only, unit g
43003	03002		
43004	03003	Predicted weight	Read-only, unit g
43005	03004	Predicted time	Read-only, unit g
43006	03005	Turn off the cut-off point weight after the slow plus delay	Read-only, unit g
43007	03006		

43008	03007	Average the predicted constant weight difference	Read-only, unit g
43009	03008		
43010	03009	Fixed weight	Read-only, unit g
43011	03010		
43012	03011	Quick plus prediction function switch	1: Turn on the Quick Plus Prediction feature 0: disables the quick plus prediction feature
43013	03012	Quick plus predicts the cache size for reads and writes, with a default value of 0	How many ADs to choose for prediction
43014	03013	Fast mode (fixed value prediction function switch)	The current fixed value prediction switch
43015	03014	Fast Mode Sampling Delay (Fixed Time Threshold)	The fixed value predicts how long the base weight will be sampled after the droplet is closed, in ms
43016	03015		
43017	03016	Fast Mode Sample Weight (Constant Weight Difference)	The difference between the base weight and the exact fixed weight, in g
43018	03017		
43019	03018	Quick mode setting time	When Quick Mode is enabled, this value is used instead of the fixed time
43020	03019	The number of times the quick mode resampling interval is used	After the interval of how many times, the weight is sampled again
43021	03020	The number of quick mode samples	The average of how many scales are used to calculate the sample weight

Note: The above is all the contents of Modbus communication address table of AF-25KII - 103B/ AF-50KII -103B automatic quantitative unit.If the device is equipped with a 7 - or 10-inch touch screen, read all of Chapter 7 carefully.Do not read Chapter 7 if the device is not equipped with a touch screen.

7. Touch screen Operation Instructions (optional)

7.1 Login screen

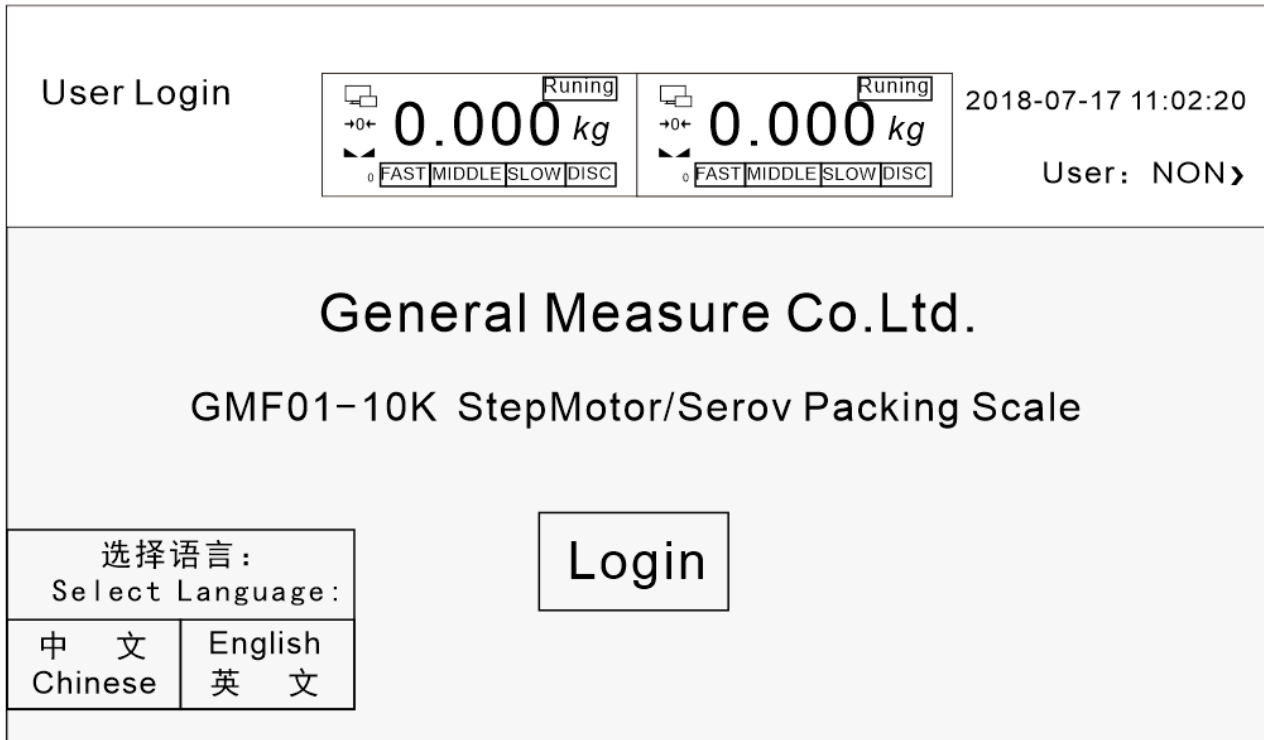

Interface Description: The interface is displayed after startup and before login.

Operating instructions for buttons and operation boxes (applicable to all operating interfaces of the device):



1. **Setting** Click this button to enter the parameter setting interface.









2. **Auto Setting** Click this button to enter the automatic scale adjustment interface.



3. **History Data** Click this button to enter the historical data interface to view relevant data.



4. **Zeroing** Click this button to perform a reset operation.

5.  Stop Click this button to make the device emergency stop.
6.  Stop Click this button to start and stop the device.
7. 0.300s Click this type of operation box to modify this value.
8.  Click this type of operation box to select and set this definition.
9.  Click this type of operation box to perform corresponding operations.
10.  Click this type of operation box to set the opening and closing of corresponding functions.
11.  Previous Page Click this type of operation box to switch pages.

7.2 Touch screen login permission description

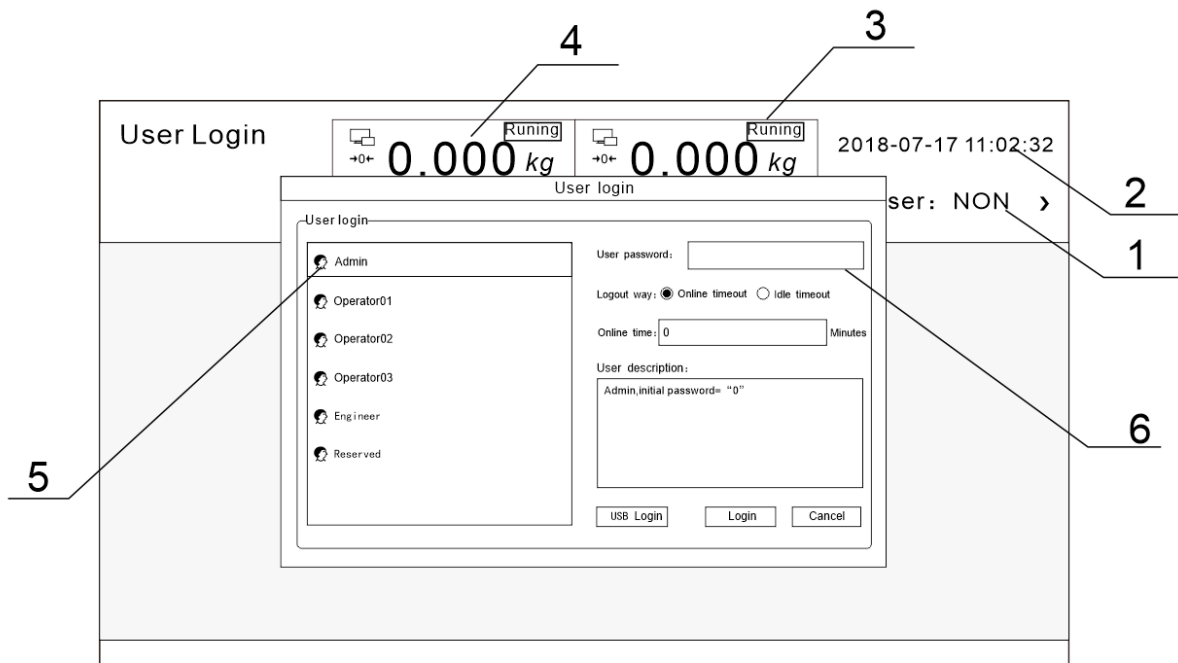

Interface description:

1: indicates the level of the current login user.

- 2: indicates the system date and time, indicating the current system date and time.
- 3: indicates the working status of the equipment.
- 4: Weight display area, display the current weight and weight unit, if the weight overflow or sensor overflow, there will be text prompt in this area, such as: "weight overflow", "weight overflow", etc.
- 5: Login user selection area, showing all users that can be selected.
- 6: User password input box, select a user account and enter the corresponding user password

user name	user	Password	limits of authority
Admin	administrators	0	Not allowed: scale calibration/switching value/motor parameters, etc
Operator01	Operator01	1	it is not allowed to set the scale calibration/switching value/motor parameters/system information, etc
Operator02	Operator02	2	
Operator03	Operator03	3	
Engineer	Engineer	Please obtain the password from the manufacturer	Unlimited operation
Reserved	Reserved	No user action required	No user action required

For specific operation methods, please refer to Chapter 7.1 "Operating Instructions for Buttons and Operation Boxes".

7.3 Main Interface description

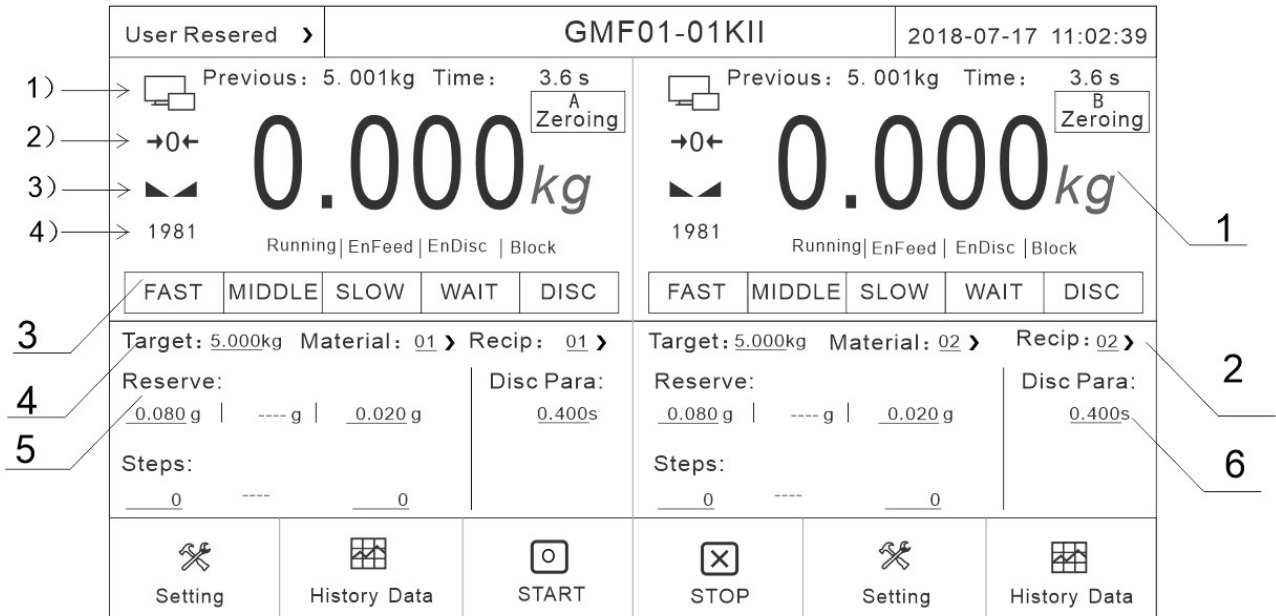

Interface description:

1. Current weight and equipment status, where:

- 1) Communication status. When the communication is normal, the icon is green.
- 2) Zero flag. When the current weight is at zero, the icon is green.
- 3) Weight stability indicator. When the weight is stable, the indicator icon is green.
- 4) Opening mark, opening of current material door.

In addition, there are allowed feeding, unloading, operation or stop status display.

2. The current material number and formula number can be set to replace the formula or material. Click the "Formula Setting" button on the right to modify the current formula parameters.

3. Each state of the device when it is running. When the device is in the stopped state, the corresponding manual operation can be performed (the runtime operation is invalid).













4. Current target value.

5. The feed cut-off advance value and target value under the current formula.

6. Discharge time and feeding door opening Settings under the current formula.

For specific operation methods, please refer to Chapter 7.1 "Operating Instructions for Buttons and Operation Boxes".

7.4 The parameter setting page is described

Setting < HOME				2021-09-26 10:02:26 User: Rervered >
 Work Parameters > Zeroing, digital filter, stable judgment	 Recipe Parameter > Target, Reserves, Steps...	 Auto Setting > Process parameter self-learning		
 Quick mode parameter > Mode Sample Delay	 Control Parameters > Frequency, Door Opening	 History Data (HMI) > Query, export, clear data		
 Calibration > Capacity, calibration...	 I/O > Define, Test...	 Communication Para. > Protocol, baud rate, format		
 User Management > Password modification, logout	 System Information > Version, Backup, Upgrade...			

Interface description:



parameter	illustrate
Working parameters	basic parameters of the product can be set, such as zero clearance range, zero clearance time, unloading mode and so on.
Recipe Parameter	can modify the current formula number, as well as the parameter value of the current formula to modify, such as modify the lead quantity, material door opening, unloading time, etc.
Auto Setting	Can only set up the target and the scale number, click the start after adjustment scale button, the equipment is up and running, in setting the number of times to adjust the value of each schedule, after completing the scale number, if meet the needs

	<p>of users, the user can press the save button, will automatically adjust the data as the current formula value after the nc data, if give up, The debugging data is restored to the factory default data.</p>
Quick Mode parameter	<p>When the scale body is relatively stable, this function can be turned on for fast packaging</p>
Control parameters	<p>parameters of the feeding motor can be set.</p>
Historical data	<p>You can query previous packing records on the historical data screen and export the packing records to a USB flash drive.</p>
Calibration scale	<p>zero calibration, weight calibration, material calibration, and maximum range setting.</p>
I/O	<p>Users can define and set the input quantity and output quantity according to their own requirements. The control board has 8 inputs and 8 outputs (for details, see 7.12 Switch Quantity Description).</p>
Communication parameters	<p>the communication parameters of the product can be set. Serial port 1 is used to communicate with the touch screen. The parameters cannot be modified, but can be adjusted automatically through the serial port. Serial port 2 can be used as an external serial communication interface. The communication parameters can be set by oneself, but should be consistent with the communication equipment (see 7.10 Communication Interface description for details).</p>
User management	<p>Switch user rights.</p>

System information	Displays the current touch screen software version and control board software version. You can also update the control board program using the USB flash drive (for details, see 7.14 USB Flash Drive Upgrade Description).
--------------------	---

Users can also reset the parameters, time and screen display related Settings. For specific operation methods, please refer to Chapter 7.1 "Operating Instructions for Buttons and Operation Boxes".

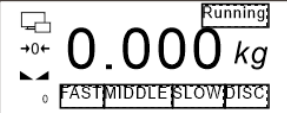
7.5 Description of working parameters

A-Work Para.-1 ◀ Parameters Setting			2018-08-18 10:02:26 User : engineer ▶
Zeroing Range:	10%	Stable range/time:	1d 0.300s
Auto Zero Interval:	0	DigitalFilter (Running)	Feed: 7 Wait: 3 Disc: 8
Additional Clear Nums at sart:	3	Digital filter level[STOP]	9
Delay Time for Zeroing:	0.200s	Add to Total When(M)Disc:	<input type="checkbox"/>
Automatic Zero When powered on:	<input type="checkbox"/>	Result Holding:	<input type="checkbox"/>
Zero Tracking Range/Time:	1d 0.200s	Self Adaption:	<input checked="" type="checkbox"/>
Processing of Zeroing failure:	Waiting for stability ▶	Auto Setting/ Self Adaption Level	Level2[balanced] ▶
◀ HOME		Next Page ▶	

Example diagram of working parameters (4 pages)

Interface description:

parameter	illustrate
Zeroing range	Zeroing range (1% to 20% of full scale).
Automatic reset interval	During operation, the device automatically resets after completing the set number of packets.

Start additional reset times	After the device enters the operating state, the second scale starts and continues to reset before feeding. The number of executions is equal to the set value of this parameter. For example, if the start additional reset times are 2, then after starting, the second and third scales are all reset before feeding.
Zeroing additional delay	When it is necessary to reset (whether it is an automatic reset interval or an additional reset), before resetting, the device completes the pre feeding delay and after this delay, the reset operation begins.
Power on automatic reset:	When the device is powered on, it automatically performs a reset operation.
Zero point tracking range/time	The zero point tracking range is optional from 0 to 9d. If it is 0, zero point tracking will not be performed. The zero point tracking time can be set from 0.001 to 9.999.
Automatic Zeroing Failure Handling	The handling method after automatic cleaning failure, including: next package cleaning, three package failure suspension, continuous stabilization, and immediate suspension.
Stability range/time:	The stability range is optional from 0 to 99d. If the change in weight within the stability time does not exceed the stability range, it is considered stable. Otherwise, it is considered unstable.
Operation filtering level:	The filtering level used during operation, ranging from 0 to 9 levels, can be divided into three situations: feeding, constant value, and unloading. The larger the value, the better the filtering effect, but the greater the lag.
Stop filtering level:	The filtering level used in the stop state, ranging from 0 to 9 levels. The larger the value, the better the filtering effect, but the greater the lag.
When manually	Accumulated manual unloading: weight is included in the accumulation.

unloading, the packaging	
Fixed value weight maintenance	weight display remains unchanged until the unloading is completed.
Adaptive switch	If the device is turned on during operation, the device will automatically adjust the scale based on the adaptive level.
Adaptive& Automatic Scaling Level	It can be divided into five levels: Zero level is the best speed, first level is slightly better speed, second level is balanced adjustment, third level is slightly better accuracy, and fourth level is the best accuracy.
Unloading mode	divided into two modes: time controlled unloading and zero zone delayed unloading. The former is to close the unloading door when the unloading time is reached, while the latter is to start the "delay after unloading to zero zone" when the weight is less than the zero zone value. When the delay time is reached, the unloading door is closed.
Delay after unloading to the zero zone	When the weight of the material reaches the zero zone value, delay the time to close the unloading door.
Unloading timeout time	If the unloading process exceeds the set time, the device will prompt a unloading timeout alarm message and automatically return to the stop state.
Fixed value mode	divided into two modes: time fixed value and stable value judgment.

Fixed value timeout time	If the fixed value is not completed within this time, it enters the fixed value timeout processing.
Fixed value timeout processing	You can choose to not pause the timeout alarm, only pause the three guarantees alarm, continue to alarm and wait for stability, and continue to alarm and pause.
Over range feeding protection	zero point (plus the part that has been cleared from zero) and has a large weight. If it is equal to 1.2 times the upper limit of the quantitative range, it enters an overrange protection state. This function can prevent the occurrence of a situation where the weight is displayed as small but has actually overflowed after clearing the larger weight to 0.
Positive error mode	During the feeding process after opening, the error generated by the feeding result will deviate from the positive value.
Bag loosening mode	You can choose between automatic bag loosening or manual bag loosening.
Delay after bag clamping/loosening	After the bag clamping or bag loosening signal is output, delay the time to stop the signal output.
Delay before loosening the bag	If the fast heater does not end after this time, it is determined as the fast heater is cut off
The timeout period of fast addition and interruption	If the fast addition does not end after this time, it is judged that the fast addition is interrupted
Intelligent	When turned on, enter the intelligent judgment mode for fast heater disconnection. Abnormal slow feeding speed will be recognized

judgment of fast heater cutoff	Don't cut off the flow
Discharging and rapping times	Number of rapping outputs, initial value: 0, indicating that the function range is closed: 0-9
Effective time of unloading and vibrating	Effective time of rapping output, initial value: 0.5; Range: 0.0~9.9. Unit: s
Discharge rapping interval time	The interval time between each rapping, initial value: 0.5; Range: 0.0~9.9. Unit: s
Operating frequency of discharge motor	Working frequency of discharge motor, initial value: 10; Range: 1-50 Unit: kHz (discharge machine Available when the construction type is servo motor)
Starting frequency of discharge motor	Starting frequency of discharge motor, initial value: 5; Range: 1-50 Unit: kHz (discharge mechanism Available when the type is servo motor)
Unloading door closing timeout	During operation, if the unloading door is not detected to be closed in place within this time, it is judged that the unloading door has exceeded the limit Time. Initial value: 3; Range: 0.0~9.9. Unit: s (discharge mechanism type is servo electric) Available during machine hours)
The discharge motor closes the door to replenish the number of pulses	The number of pulses that go forward after triggering the signal to close the door in place

Set batch number	The set batch number.
Number of remaining batches:	The number of remaining batches.
Forced use of three-level feeding:	When turned on, enters the three-level feeding mode.
AB interlocking scale body mode	Single scale. When using dual scale interlocking, set the parameter of A scale to interlocking A scale, and set the parameter of B scale to interlocking A scale Parameter set to interlock scale B)
Type of feeding mechanism	Pneumatic and servo motors are optional
Charging motor type	There are stepper motor-shaft drive, servo motor-shaft drive, and stepper motor-connecting rod options
Vibrating plate	There are options with and without vibrating plate
Type of discharge mechanism	Optional pneumatic and servo motors
Scale specifications, vibration plate, and motor type	The functions are set by the manufacturer and cannot be set by engineer users.

For specific operation methods, please refer to Chapter 7.1 "Operating Instructions for Buttons and Operation Boxes".

7.6 Description of formula parameters

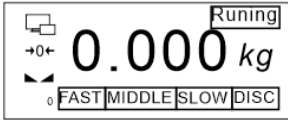
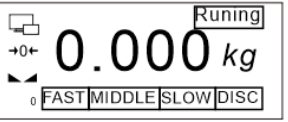
A-Rec. Para.-1						2018-08-18 10:12:26
Parameters Setting				User:engineer		
Target:	5.000kg			Recipe ID:	09	
Fast Remains:	3.800kg	Automatic adjustment >	Fast Steps:	16001		
Middle Reserve:	-----kg		Middle Steps:	----		
Slow Reserve:	0.038kg		Slow Steps:	----		
Disc Mode:	Time Control Disc >					
Disc Delay Time:	0.200s			Waiting Time:	0.800s	
	Multiple Disc Num:				00	
		< HOME		Next Page >		

Formula parameters 1 diagram

Interface description:

parameter	illustrate
Target value	A quantitative weight is required.
Fast acceleration advance	During the quantitative process, if the weighing value is \geq the target value - fast acceleration advance, the fast acceleration will be turned off.
Intermediate plus advance	During the quantitative process, if the weighing value is \geq the target value - intermediate plus advance, the intermediate plus will be turned off.
Drop value	During the quantitative process, if the weighing value is \geq the target value - drop value, the slow acceleration will be turned off.
Unloading mode	Time controlled unloading or zero zone delayed unloading can be selected.



Unloading time	The unloading signal output stops after this time.
Zero zone value	During the quantitative process, if the weighing value is less than or equal to the zero zone value, the unloading delay timer will be activated.
Recipe Number	The number of the current recipe.
Quick feeding opening	The opening of the feeding door during rapid feeding of materials.
Medium opening	The opening of the feeding door when adding materials.
Slow feeding opening	The opening of the feeding door during slow feeding of materials.
Discharge opening	The opening of the discharge door when discharging. (Available when the discharge mechanism type is servo motor)
Fixed value time	The time to determine the weight after the feeding is completed.
Combination times	This is a reserved parameter, and the current device does not support the multi scale combination function.
Delay T1 before feeding	At the beginning of the quantitative process, the feeding process only starts after a delay T1 time;
Slow feeding switch	When this switch is turned on, the equipment automatically performs slow feeding.
Single replenishment	The time of a single replenishment.

time	
Maximum replenishment frequency	The maximum replenishment frequency of the equipment.
Over/under tolerance switch	A switch that enables the over/under tolerance detection function.
Over tolerance	During the quantitative process, if the weighing value is greater than the target value+over tolerance value, it is considered over tolerance.
Under tolerance	During the quantitative process, if the weighing value is less than the target value - under tolerance value, it is considered under tolerance.
Over/Under tolerance alarm time	The duration of the over/under tolerance alarm output after detecting over/under tolerance. After this time, the over/under tolerance alarm automatically outputs invalid.
Over/under tolerance pause switch	When this switch is turned on, if over/under tolerance occurs, the device will pause and wait for user processing. At this time, it can "clear the alarm" and continue running; It can also return to the stop state after an "emergency stop".
Fast heater cutoff timeout	If the fast heater does not end after this time, it is determined as the fast heater is disconnected. If the interruption timeout is large At 10S, this function is invalid
Intelligent judgment of fast heater cutoff	Turn on the switch, and the system will automatically determine that the fast heater is disconnected. If the feeding speed slows down abnormally, it will be recognized as disconnected
Opening weight	When the fast heater is cut off, if the remaining weight to be added exceeds this value, the opening of the fast heater will become cut off

of cut-off safety opening	Flow safety opening. If it is less than this value, it will directly turn off the fast acceleration and jump to the slow acceleration
Safety opening for flow interruption	This opening ensures that the material will not become overweight when it is immediately flushed down when it comes back in. Should be set to obviousLess than normal fast acceleration opening. But this opening can also ensure that the feeding speed is greater than the slow feeding.

For specific operation methods, please refer to Chapter 7.1 "Operating Instructions for Buttons and Operation Boxes".

7.7The Quick Mode Parameters interface says

A-Quick Mode Para.		 Running +0+ 0.000 kg FAST MIDDLE SLOW DISC		 Running +0+ 0.000 kg FAST MIDDLE SLOW DISC		2021-09-26 10:02:26	
Parameters Setting				User: Reserved			
Quick Mode:	<input type="checkbox"/>	Fast Infer Cutoff	<input type="checkbox"/>				
Quick Mode Sample Delay:	__0 mS	Fast Infer Cutoff Smoothly Sampling	<input type="checkbox"/>				
Quick Mode Sample Slow Reserve:	__0 g	QDF:	<input type="checkbox"/>	Quick Mode:	<input type="checkbox"/>		
Quick Mode Waiting Time:	0.000 s	COM3Debug:	<input type="checkbox"/>	DΔset:	__0 g		
Quick Mode Sample Number:	__0	Yon:	<input type="checkbox"/>	Dtd:	__0 mS		
Quick Mode Sample Interval:	__0	Samp4:	<input type="checkbox"/>	Dwc:	0.000 kg		
Pre-Filter:	<input type="checkbox"/>	YΔW:	0 g	DΔW:	0 g		
		Ywc:	0.000 kg	Dwp:	0 g		
		Ywp:	0 g	Dtp:	0.000 S		
		Ytp:	0 uS	DsmpN:	0 __0		
				DdisN:	__0		
< HOME							

Interface specification:

parameter	illustrate
Quick mode switch	It is used to turn on the quick value function

Fast mode sampling delay	The fixed value predicts how long the base weight will be sampled after the droplet is closed
Fast mode sampling drop	The value of the drop calculated in fast mode
Quick mode setting time	The number of sample packets in fast mode, this time will be used as the fixed time
The number of quick mode samples	The average of how many scales are used to calculate the sample weight
The number of times the sampling interval is in fast mode	After the interval of how many times, the weight is sampled again. There is no need for a fixed time during the number of intervals, which speeds up
Quickly predict the shutdown	Through the first few samples, predict the weight of the fast add, or turn off the fast add in advance
Quick prediction turn-off smoothing sampling	After it is enabled, it is predicted based on the fast trend of the last 4 packs, and closed is predicted only based on the fast trend of the current pack
Pre-filtering	A simple filter has been added before filtering for smoother weight results

7.8 Calibration interface description

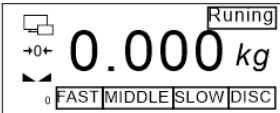
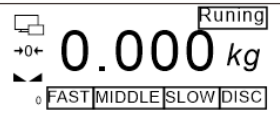
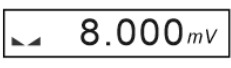
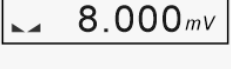
A-Calibration				2018-08-18 10:12:26 User:engineer >
< Parameters Setting				
Unit: ["kg" only]	kg >	Decimal point:	0.000 >	
Minimum Division: [1d=0.001kg]	01 >	Capacity:	15.000kg	
Over Capacity mode: Cap*120% >				
Step 1: Confirm that the hopper is empty and the discharge door is closed, Wait for the indication to be stable, click the buton to complete the clibration!		Step 2: Add standard weight, wait until the display is stable, input the actual weight, and click the button!		
Loadcell Output-mV:		Zero Calibration	Weight-mV:	
			Weight:	3.000kg
			Weight Calibration	
		< HOME		Calibration with materials >

Interface specification

parameter	illustrate
Unit	The fixed value is kg
Minimum score	1 2 5 10 20 50 Optional.
Display mode of overrange	there are three options: when the current weight is greater than: maximum range + 9D, maximum range *120%, and maximum range *150%, the device will prompt weight overflow.
Decimal point	fixed value 0.000, that is, three decimal places after the decimal point.
Maximum range	maximum range of the device (do not set it to more than 20.00kg).

For specific operation methods, please refer to Chapter 7.1 "Operating Instructions for Buttons and Operation Boxes".

7.9 Step of weight calibration

1. Zero point calibration: empty the hopper and close the discharge door. Click "Zero point Calibration" after the weight is stabilized. During the calibration process, the weight display area above will display the calibration result, and stability will be displayed after successful calibration.
2. Gain calibration: Add weights to the weighing mechanism, click the weight input box after the weight is stable, input the weight of the weight, click "weight Calibration", the weight display area above the calibration process will also display the calibration result. After successful calibration, the weight displayed in the weight display area is the input weight. Otherwise gain calibration fails. Try again.

For specific operation methods, please refer to Chapter 7.1 "Operating Instructions for Buttons and Operation Boxes".

7.10 Material calibration steps

Calibration with materials < Parameters Setting	Running +0+ 0.000 kg FAST MIDDLE SLOW DISC	Running +0+ 0.000 kg FAST MIDDLE SLOW DISC	2021-09-26 10:02:26 User □ engineer >
Step1: Empty the scale bucket and wait for the MV value to The indication should return to zero.	12.000 mV	Zero Calibration	
Step2: Click "automatic feeding"[by target value]or "(M)Fast"[by time]. Start charging. (please make sure the weight has been calibrated before automatic charging, The weight is roughly accurate, otherwise it may be filled with overflow, etc) Wait until the weight indication is stable, click "record weight" to save the current displayed value Bag claming and unloading. weigh on the standard scale to obtain the weight of the double scale (pay attention to peeling)	Target: 5.000kg Auto Feeding Ufeeding (M) Feeding TIME: 1.0s	Current Weight: 1.000kg Save the weight	(M) Disc
Step3: Input the weight of the weigher, click "automatic feeding", and the controller will automatically Record the weight Calibration as the weight of the scale	Standard weight: 3.000kg	Calibration with materials	
< Weight Calibration		< HOME	

1. Zero calibration: the method is the same as the zero calibration of the weight calibration scale.

2. Gain calibration:

A. Use "automatic feeding" (automatically run a scale according to the current formula target value) or "manual feeding" (click once to start fast adding, click again to close fast adding), stop feeding and wait for the weight to stabilize, click "Record Weight" to save the current displayed value.



B. Place the bag or container prepared in advance at the unloading port, click "Manual unloading", unload all the materials in the hopper into the bag or container, weigh the

materials in the bag or container (pay attention to remove the weight of the bag or container).

C. Click the input box of "Compound weight", enter the weight of the material obtained by the compound weight, and click "Material Calibration" for calibration. Wait until the calibration succeeds. After successful weight calibration is completed, exit the menu.

For specific operation methods, please refer to Chapter 7.1 "Operating Instructions for Buttons and Operation Boxes".

7.11 Description of switch quantity interface

A-I/O-1:Input				2018-08-18 10:12:26	
Parameters Setting				User:engineer	
Port	Define	Status	Port	Define	Status
IN01	START	<input type="radio"/>	IN05	Bag clamping request	<input type="radio"/>
IN02	Emergency Stop	<input type="radio"/>	IN06	undefined	<input type="radio"/>
IN03	Clear alarm	<input type="radio"/>	IN07	undefined	<input type="radio"/>
IN04	Interlock input	<input type="radio"/>	IN08	undefined	<input type="radio"/>
A-IO <input type="checkbox"/>		OUT <input type="checkbox"/> <input type="checkbox"/> <input type="checkbox"/> <input type="checkbox"/> <input type="checkbox"/> <input type="checkbox"/> <input type="checkbox"/> <input type="checkbox"/> <input type="checkbox"/> <input type="checkbox"/>	A-I/O Test: <input type="checkbox"/>		
B-IO <input type="checkbox"/>	IN <input type="checkbox"/> <input type="checkbox"/> <input type="checkbox"/> <input type="checkbox"/> <input type="checkbox"/> <input type="checkbox"/> <input type="checkbox"/> <input type="checkbox"/> <input type="checkbox"/> <input type="checkbox"/>	OUT <input type="checkbox"/> <input type="checkbox"/> <input type="checkbox"/> <input type="checkbox"/> <input type="checkbox"/> <input type="checkbox"/> <input type="checkbox"/> <input type="checkbox"/> <input type="checkbox"/> <input type="checkbox"/>	<input type="checkbox"/> To B Scale		
HOME				Next Page	

Switching Quantity Example Diagram (3 Pages)

Parameter Description:

parameter	illustrate
Input	Input ports (IN01, IN02, IN03, IN04, IN05, IN06, IN07, IN08) can be customized by customers (PWM1-ZT1_1, PWM1-ZT1_2) is fixed as the photoelectric signal of the motor in place; Input Port (PWM2-ZT2_1, PWM2-ZT2_2) is a universal switching value, where PWM2-ZT2_1 has been set as servo alarm by default, PWM2-ZT2_2 Customizable by customers (When the corresponding PWM port function is set to motor control, PWM1-ZT1_1, PWM1-ZT1_2, PWM2-ZT2_1, and PWM2-ZT2_2 are fixed as motor in position photoelectric and cannot be set. When set to switch value, they are used as ordinary input ports)
Output	(OUT01, OUT02, OUT03, OUT04, OUT5, OUT6, OUT7, OUT8) can be customized by customers

	<p>(DR1, PU1) is the direction signal and pulse signal of the motor; The output ports (DR2, PU2) are general-purpose switching variables, The default setting for DR2 is slow acceleration, while the default setting for PU2 is unloading</p> <p>(DR1, PU1, DR2, and PU2 are fixed to the motor direction and pulse when the corresponding PWM port function is set to motor control)</p> <p>Impulse output, cannot be set. When set to a switching value, as a normal input port)</p>
Switching Value test	After being turned on, you can test whether the corresponding switching value signal is normal.

For specific operation methods, please refer to Chapter 7.1 "Operating Instructions for Buttons and Operation Boxes".

Input definition:

The port number	The initial value	Custom list
IN1	1	I00: No definition I01: start I02: stop
IN2	2	I03: stop I04: Feeding stepper motor origin (close the door to
IN3	5	A level) I05: Feeding allowed
IN4	6	I06: Unloading allowed I07: Clear alarm I08: keep
IN5	0	I09: Open/close unloading door [originally manual unloading

IN6	0	Function, switch discharging output state] I10: Manual unloading
IN7	0	I11: Manual slow add I12: Manually add I13: Manual fast add [by fast open open
IN8	0	The door] I14: Manual cleaning [open according to the maximum opening
ZT1_1	4	The door] I15: Start/stop (double edge: effective edge,
ZT1_2	24	Start;Invalid edge, stop) I16: Start/emergency stop (double edge)
ZT2_1	0	I17: Manual unloading (double edge) I18: Manual slow adding (double edge)
ZT2_2	0	I19: Manual adding (double edge) I20: Manual quick add (double edge) I21: Manual cleaning (double edge) I22: reset I23: Emergency stop [level](valid, no Start allowed, manual feeding not allowed, not allowed Manual unloading is allowed)



		<p>I24: feeding stepping motor limit point.</p> <p>I25: Unloading stepping motor origin.</p> <p>I26: limit point of unloading stepping motor.</p> <p>I27: jam</p> <p>I28: Servo motor alarm</p> <p>I29: Double scale interlock input</p> <p>I29: AB interlock input</p> <p>I30: Unloading servo alarm</p>
--	--	---

Output definition:

The port number	The initial value	Custom list
OUT1	1	O00: No definition
OUT2	4	Run O01:
OUT3	5	O02: Refueling request
OUT4	6	O03: Feeding stepper motor direction [PW available
OUT5	7	The signal is set to feed PWM]
OUT6	0	O04: quick to add
OUT7	0	I add O05:
OUT8	0	O06: slow
DR1	3	O07: fixed value
PU1	0	O08: unloading L
DR2	8	O09: over difference
PU2	0	O10: alarm
		11: clip bag
		O12: Preset number of packets completed
		O13: Once packing is completed (unloading is completed
		After output 1s clock)
		O14: stop
		O15 unloading step motor direction
		O16 Discharging motor running/forward
		O17 discharging motor reverses
		O18 feeding PWM[only AVAILABLE for OUT7/OUT8]

		O19 Discharging PWM[only available at OUT7/OUT8] O20: Feeding servo alarm output O21: Fixed value completion O22: AB interlock output O23: Unloading servo alarm output O24: Unloading status output
PWM1 function	2	1: general switching quantity 2: feeding motor control 3: unloading motor control
PWM2 function	1	

7.12 Control Parameters screen Description

A-Control Parameters		 Runing 0.000 kg <small>FAST MIDDLE SLOW DISC</small>	 Runing 0.000 kg <small>FAST MIDDLE SLOW DISC</small>	2018-08-18 10:12:26
Parameters Setting		User:engineer		
Disable judgment Time	0.700/ 0.700/ 0.700 s	Feeding StepMotor Status:	RUN CLOSE ZERO 2198	
Disable judgment Time Auto Adjust	<input type="checkbox"/>			
		Feeding StepMotor Work Frequency	60.0kHz	
		Feeding StepMotor Start Frequency	20.0kHz	
Feeding StepMotor Max.Step:	20000	Fast Steps:	6123	Feeding StepMotor Steps Tab
		Fast Steps:	4123	
		Slow Steps:	2	
< HOME				

Interface specification



parameter	illustrate
Prohibition time	At the beginning of quantification, to avoid overshoot, weight judgment is not performed at this time. Fast acceleration, medium acceleration, and slow acceleration are always effective

for fast, medium, and slow acceleration	
Slow acceleration intelligent prohibition switch	When this switch is turned on, the slow acceleration intelligent prohibition function is enabled.
Motor Subdivision	Set value of motor subdivision
Reducer reduction ratio	The reduction ratio of the current reducer.
Maximum angle of feeding gate	the maximum opening angle of the current feeding gate.
Maximum opening degree of charging motor (pulse number)	To protect the motor, the maximum opening degree allowed after starting the motor is allowed.
Initial Opening Calibration Value	The calibration value of the current initial opening
Feeding motor status	four states can be seen: stop, open, origin, and opening.
Feeding motor	the frequency at which the feeding motor operates normally.

operating frequency	
Starting frequency of charging motor	the frequency at which the charging motor is started.
Quick heater opening	the current fast heater opening value.
Medium Plus Opening	The current medium plus opening value.
Slow heater opening degree	the current slow heater opening degree value.

For specific operation methods, please refer to Chapter 7.1 "Operating Instructions for Buttons and Operation Boxes".

7.13 Communication Parameters screen description

A-Communication Para.		 Running <div style="text-align: center; font-size: 24pt;">0.000 kg</div> <div style="text-align: center; font-size: 8pt;">FAST MIDDLE SLOW DISC</div>		 Running <div style="text-align: center; font-size: 24pt;">0.000 kg</div> <div style="text-align: center; font-size: 8pt;">FAST MIDDLE SLOW DISC</div>		2018-08-19 10:09:36	
Parameters Setting				User:engineer			
A-COM1	Used to this HMI, Cannot set:			A-LAN	The LAN port on the controller. Not the LAN port on this HMI.		
ID:	001			IP and Port:	0.0.0.0:000		
Protocol:	Modbus-RTU			Protocol:	Modbus-TCP/IP		
BAUD:	[may not be default, adaptive]	57600		DoubleWord Format:	AB-CD		
Byte Format:	[Parity bit can be different]	1-8-E-1		MAC:	00:00:00:00:00:00		
DoubleWord Format	AB-CD						
HMI parameters:	COM2	57600	Even				
HOME				Next Page			

Example diagram of communication parameters (2 pages)

Interface description:

parameter	illustrate
Address number	Slave number. The ID number of the serial communication
Protocol Type	Communication protocol. Select the protocol for serial communication
Baud Rate	Select the baud rate of the serial port.
Byte Format	Data format. Initial value; 1-8-E-1 (8-bit data bit-even parity - 1-bit stop bit;)
Double word register order	Modbus high and low words The order in which high words come first is AB-CD, and the order in which low words come first is CDAB.

Current HMI communication parameters	Displays the current communication parameters of the touch screen.
IP and Port	IP address.
MAC	MAC address.

7.14 Historical data page description

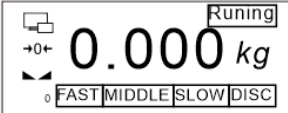
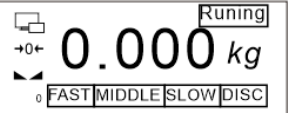

A-History Data						2018-08-19 10:09:36		User:engineer		
← HOME										
Index	TIME	Mat.Rec	Target	ACT.	Time	E	Sec.	Total PCS	Total	OP. OL.
									Select	OP. OL.
									Goto	OP. OL.
										OP. OL.
									Auto Refresh	<input type="checkbox"/>
									(M)Refresh	
									Export to Udisk	
FirstPage	PreviousPage	NextPage	LastPage	Setting	Clair Data	← HOME				

Interface description:

parameter	illustrate
Automatic refresh/Manual refresh	Refreshes data.

Usb disk export	You can export historical data.
Clear data	Clear historical data.
Historical Data (HMI)	Can view historical data saved on HMI
Historical data (controller)	Can view historical data saved on the controller
Communication Exception Record	Can view the history of communication exceptions
Alarm Record	Can view alarm records
set up	Can set the time range for data storage

7.15 Description of automatic balance adjustment interface

A-Automatic						2018-08-18 10:42:26	
Parameters Setting				User:engineer			
Material ID/Name:	03/ Material 03	Auto Setting/ Self Adaption Level:	Level2[balanced]				
Recipe ID/Tareget:	01 / 5.000kg	Steps Auto Adjust	Levels				
Fast Remains:	2.000 1.600kg	Fast Steps:	1 6123				
Middle Reserve:		Middle Steps:					
Slow Reserve:	0.008 0.005kg	Slow Step:	1123 2				
Previous: 24.998	Total Time: 3.982	Remaining NUMS: 00	Current Status: END		Give up		
Fast: 2.232 Middle: 0.000 Slow: 1.234		Auto Setting NumS: 09	Start Auto Setting		SAVE		
Wait: 0.900 Disc: 0.000 T1: 1.004							
HOME							

Interface description:

parameter	illustrate
Material No./Name	You can set the material number and name
Recipe Number/Target Value:	Set the recipe number and target value
Adaptive& Automatic Scaling Level	There are four levels in total, with Level 0 being the fastest, and the higher the level, the slower the speed
Automatic adjustment of opening	automatic adjustment function switch for the opening of the feeding door
Feeding Level	Two or three levels of feeding, automatically set by the system based on the target value
Quick charging opening	the opening of the fast charging door.
Medium feeding opening	the opening of the medium feeding door.
Slow feeding opening	the opening of the slow feeding door.

Scale adjustment times	You can set the scale adjustment times.
------------------------	---

Automatic weighing steps and description

Schedule and the opening is divided into two columns, as shown in the above, in front of its value for the automatic tuning weigh the value of the former at the back of the numerical value for automatic adjustment scale, users only need to set the number of scales (range 3-10), click on "start adjustment scale" can be in the process of automatic adjustment scale, equipment according to set automatically adjustable scale level automatically adjustable scale, At the same time, users can choose to save or abandon the adjusted value of automatic balancing according to the adjustment value of automatic balancing. Save the adjusted value of automatic balancing into the current formula. If you give up, the value before automatic balancing will still be used. If the balance adjustment fails to meet the requirements of the user after completion, the customer can start the automatic balance adjustment again, and the equipment will adjust and modify again on the basis of the completion of the last balance adjustment. Users can also manually modify the lead and opening parameters.

7.16 Describes the user management interface

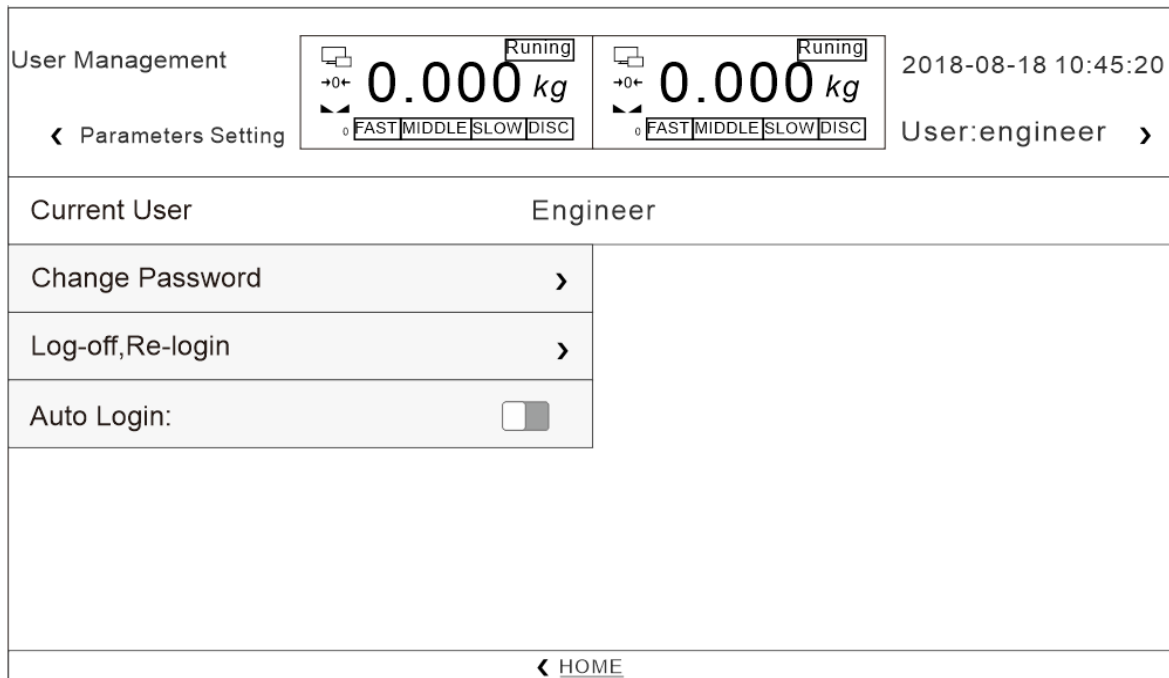

Interface description:

Displays the current logged-in user, can change password and set automatic logged-in. The user level of this system is divided into four levels, from high to low: reserved user (used by manufacturers), engineer, administrator and operator.

The cancellation

After a user logs in, to log out or switch to another user, click User Logout→

To switch a user, log out of the user management page and enter the user ID and password on the login page

Change the password

Path: parameter setting, user management, password modification, click on the password input box, and follow the prompts

For specific operation methods, please refer to Chapter 7.1 "Operating Instructions for Buttons and Operation Boxes".

7.17 System information interface description

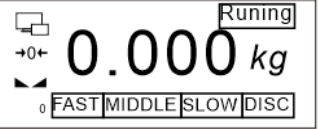
SYS Info-1: Name and Version Parameters Setting			2018-08-18 10:02:26 User:engineer
Device Name:	AF-5K StepMotor/Serov Packing Scale		
Model :	AF-5K	COM1 ID Config	
Software Version:	Weighing controller: Ver:03.02.00	2018/08/08 18:18:18	A-U-disk Upgrade
PLC:			
HMI:	Ver:01.00.02	2018/08/09 18:19:19	
Manufacturer:	杰曼科技		
Support Hotline:	(+86)0000-00000000		
< HOME		Next Page >	

Example diagram of system information (3 pages)

Interface description:

System information 1 Shows the device information diagram.You can see the device name, model number, software version, manufacturer, technical support number, and so on.

System info 2 shows the restoration of factory Settings.Engineers and reserved users can reset all parameters.Specific instructions are as follows:

Restore factory Settings - Reset all system parameters to their default Settings.

Operating parameter reset - Resets basic system parameters to their default Settings.

Calibration parameter reset - Reset system calibration parameters to their default Settings.

Recipe parameter Reset - Resets system recipe parameters to their default Settings.

Peripheral parameter reset - Resets system peripheral parameters to their default Settings.

Adaptive parameter Reset - Resets system adaptive parameters to default Settings.

Communication parameter reset - Resets system communication parameters to default Settings.

Switch quantity definition reset - Reset the system switch quantity definition to the default configuration.

System info 3 The screen setting diagram is shown. Engineers can set the parameters of the touch screen.

Usb disk upgrade system:

This operation is very important and cannot be performed unless necessary. If the operation is necessary, please contact the company and complete under the guidance of professional personnel.

8. Basic Function description

8.1 Basic running process

After the external input running signal is effective, the equipment enters the running state and begins the automatic quantitative process. The specific process is as follows:

1. Judgment before starting, whether the target value is set reasonably, whether the size of the feeding door needs to be adjusted, etc.
2. Delay time before starting feeding.
3. If the self-adaptive function is turned on, judge whether self-learning is needed again (if the current formula does not have fast increase lead amount and fall value parameters, self-learning needs to be restarted); otherwise, feed directly according to the current formula parameters. The following describes the process after the adaptive function is enabled
4. If the adaptive function is turned on, the first scale learns the approximate fast increase and drop value.
5. Start feeding normally from the second scale, and according to the feeding results of each scale, the controller will calculate automatically to judge whether the fast adding value and the drop value are appropriate and make automatic correction.
6. Start the fixed hold time after feeding.
7. Record the current weight value as the result of the scale after the fixed holding time.
8. If the overcurrent and undercurrent detection switch is turned on, the overcurrent and undercurrent detection function is processed.
9. Judge the bag input signal is effective, then output unloading.
10. When the unloading time is up, close the unloading output and start the loosening bag to delay the loosening bag.
11. After the completion of a basic packaging process, proceed to the next packaging process and start the delay time before feeding.

8.2 Overage and underage detection function

After the over-under-difference switch is opened and the feeding is completed during operation, the current feeding result is judged after the fixed holding time ends:

Target value - underdifference value \leq feeding result \leq target value + out-of-tolerance value, then judged as qualified.

Feeding result $>$ target value + overerror value, then judged as overerror, output overerror alarm signal.

If the feeding result is less than the target value - underdifference value, it is judged as underdifference, and the over-underdifference alarm signal is output.

When the overgap occurs, if the overgap suspension switch is opened, the controller will temporarily schedule the packaging operation, prompting the overgap suspension and waiting for the user to process. The user can input the clear alarm signal to continue the

packaging operation, or input the emergency stop signal to enter the stop state and stop the packaging operation.

8.3 Overage and underage detection function

1. After setting the AB scale, the unloading delay time, and the on-off signal, it defaults to the dual scale mode.

2. After the external input operation signal is valid, the device enters the operation state.

3. Judge whether the bag clamping signal is valid. In the dual scale mode, Scale A responds to the bag clamping and unloads the material. At the same time, it will output an interlock signal to Scale B, and then Scale B will automatically cancel the bag clamping request (here is an example).

4. After completing a basic packaging process, proceed to the next packaging process.

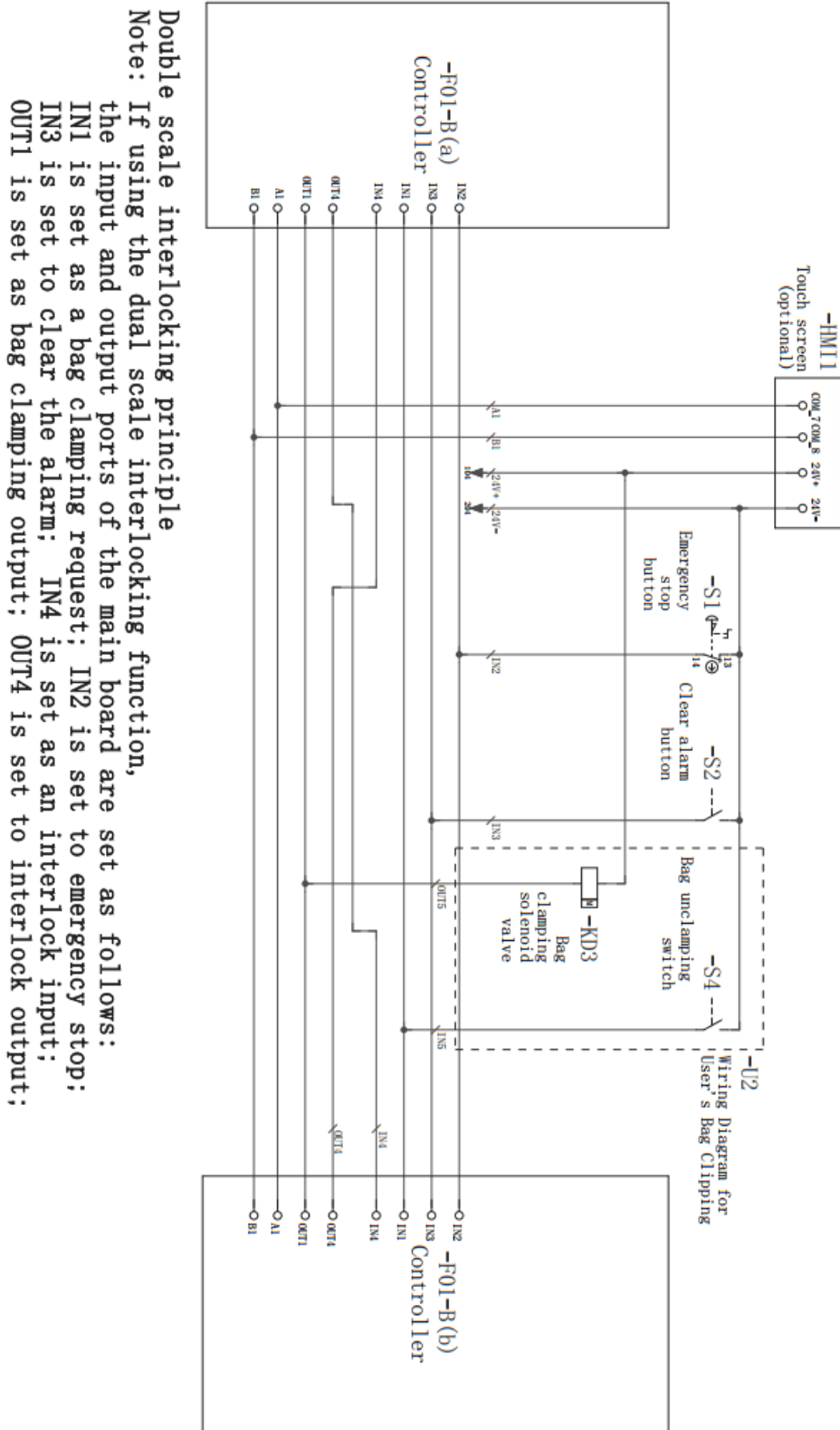

Schematic Diagram of Double Scale Interlock

9. Common failure analysis and troubleshooting

Common faults in use, causes and handling methods.

The serial number	The fault phenomenon	fault	To deal with
1	Equipment start does not fall material	1. No material in storage bin 2. Storage bin stop door is not opened 3. Air source leakage connection 4. Air source pressure is too low or no pressure	1. Add material to storage bin 2. Open the storage bin stop door 3. Connect the air source 4. Increase air pressure or turn on air pressure switch
2	No unloading after weighing	1. The device cannot receive the bagging signal 2. The number of combinations of single scales is not set to 0	1. Check and eliminate 2. Set the corresponding combination times as required
3	The actual weighing has been out of tolerance	1. Equipment not calibrated 1. Fast increase the time limit setting is too large	1. To a scale 2. Fast increase the time limit appropriately reduced
4	The value is unstable	1. Strong winds or strong vibrations in the surrounding environment 2. Weight sensor failure	1. Check and eliminate 2. Check the sensor and replace if necessary
5	The weight is not up to standard	1. Weight sensor failure 2. Not cleared before use 3. Equipment not calibrated 4. Incomplete unloading	1. Check the sensor and replace if necessary 2. Stop reset 3. recalibrate 4. Increase discharge time appropriately

6	Data cannot be exported	1.U disk is damaged 2.The USB interface of the electrical control box is damaged	1.Replace the U disk 2.Check the interface
---	-------------------------	---	---

10. Maintenance and warranty

To ensure the weighing accuracy of the equipment, do not place the equipment in a cold and damp environment. Clean the dust generated by materials inside the equipment regularly according to the use condition. Remember to close the door of the electric control cabinet after daily use or maintenance.

- Warranty principle

In principle, the first installation and debugging should be carried out by our professional and technical personnel or companies entrusted by our company.

Equipment failure caused by the following conditions is not covered by our warranty:

- Do not follow the operation instructions
- Installation without professional guidance
- Make structural changes to the equipment
- Unauthorized damage to equipment
- Programming and operation errors
- Natural equipment damage