



# Continuous Dosing Machine



# AB-12T/20T

## CONTINUOUS DOSING MACHINE



Efficient



Safe



Accuracy



Smart



## Product Introduction

This scale is a weighing and batching equipment with intermittent feeding and continuous discharging. During the operation, it can constant discharge with uniform mixing material and automatic flow correction. High cumulative accuracy and precise batching ratio are its outstanding features. It can be widely used in food processing, chemical, port and other industries that need continuous operation and automatic control of material flow rate.

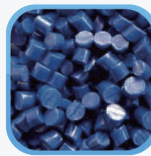

## Feature

- **Accurate weighing, stable flow:** innovative double hopper structure, the upper hopper for ensuring the total amount of accurate, the lower loss-in-weight ensure stable flow.
- **Servo feeding, stepping discharging:** servo and stepping motor control plus intelligent algorithm drive automatic flow adjustment and precise control.
- **Smart setting, automatic adjustment:** only set flow rate, the system automatically configures other parameters, easy setting.
- **Interlocking, central control:** interlocking function, optional interlocking cable and central control **HMI**, can monitor and set up to **12** scales.

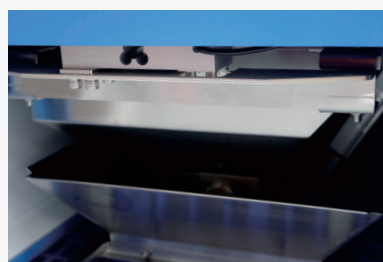

## User-friendly design

- 10-inch color user friendly touch screen and graphical design interface. Simple operation without professional training.

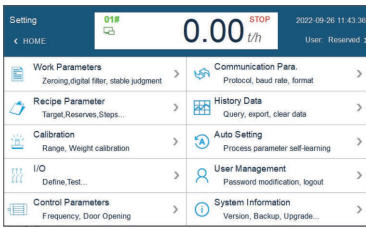

- Parameter interface optimization and upgrade.

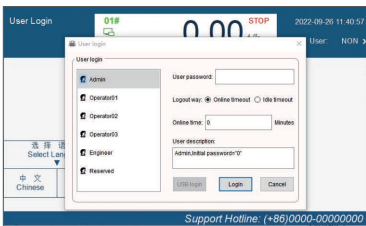

- Multi-level user management: 4 levels of user management, hierarchical authority, easy to manage.

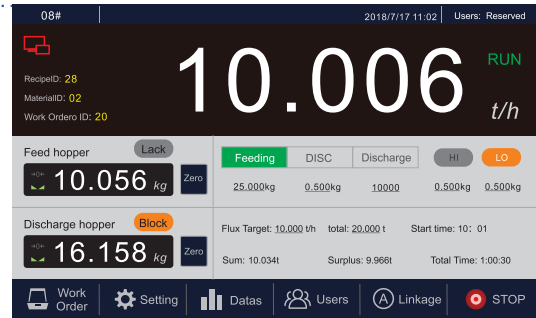

- Communication adaption: HMI automatically search for connecting controller, automatic re-connection, more stable and reliable.

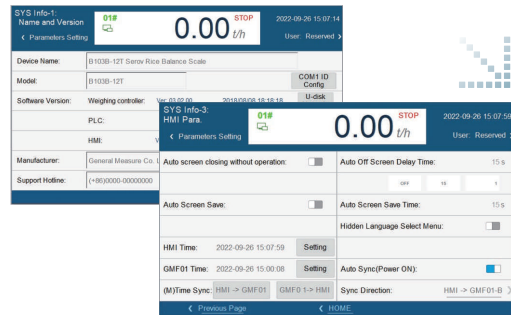

## Well-organized data management

- All definitions of each port can be intuitively selected.



- History data storage: Millions of data storage, historical data exported by USB, easy for production management.



## Specification

Model	AB-12T	AB-20T
Productivity	0.5~12t/h	0.5~20t/h
Accuracy	≤0.5%	≤0.5%
Speed	≤12t/h	≤20t/h
Volume	15L	30L
Power	0.25KW	500W
Air supply	0.4~0.6MPa	0.4~0.6MPa
Power supply	AC220V±10%, 50/60Hz	AC220V±10%, 50/60Hz
Operating temperature	0~40°C	0~40°C
Humidity	90%R.H, No Condensation	90%R.H, No Condensation

\*Depends on materials, feeding and other environment elements. The accuracy and speed show here are rice testing data.

## Structure & Dimension

Unit: mm

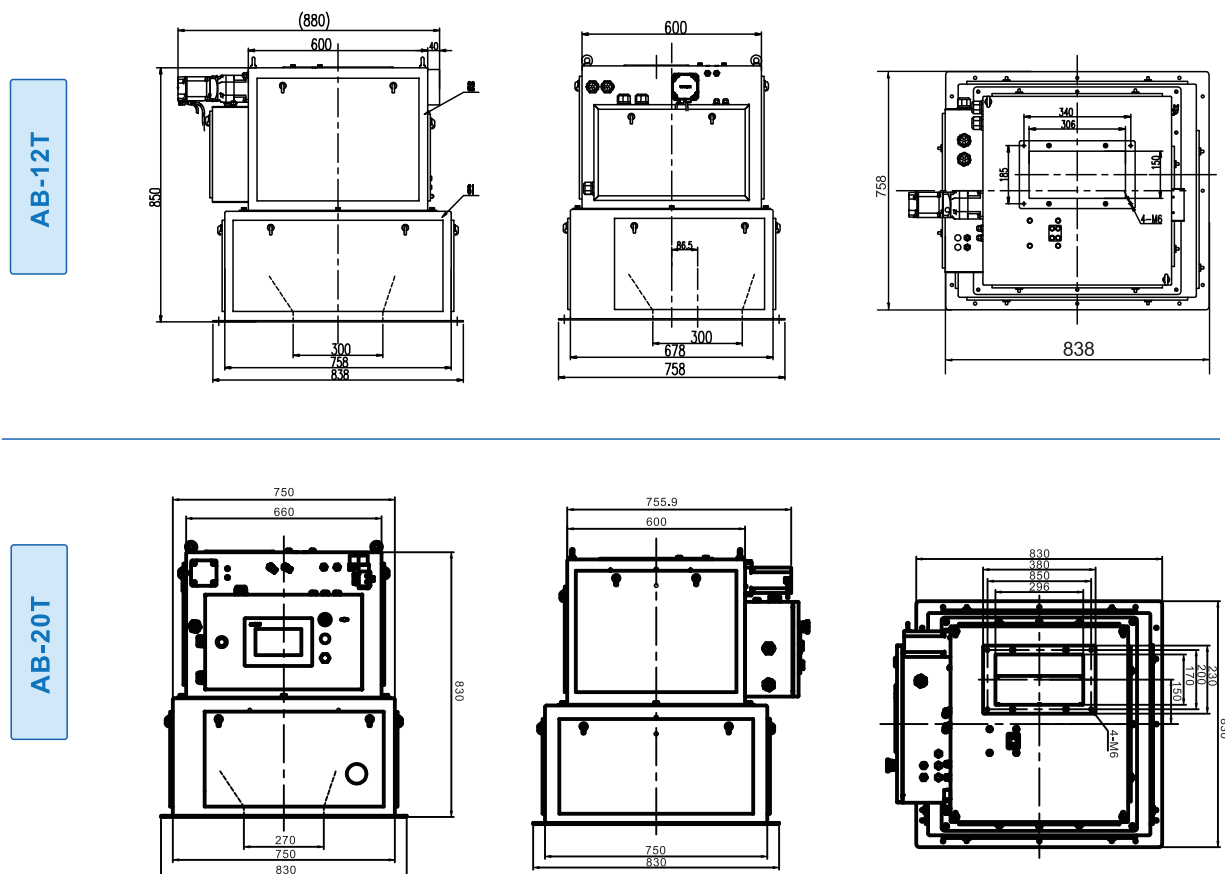

**General Measure Technology Co.,Ltd.**

Address: Room2208, Block A, Building 6, Shenzhen International Innovation Valley,

Nanshan District, Shenzhen, Guangdong Province, P.R.China.

Tel/Wechat: +86 185 6585 5789

E-mail: xjlv@szgmt.com

Website: www.gmweighing.com



Linkedin



Facebook



Wechat