



Facebook



Wechat



杰·曼·科·技

Checkweigher Solution



杰·曼·科·技

General Measure Technology Co.,Ltd.

Production base: B5, Power Valley, Tianyuan District, Zhuzhou, Hunan Province, China

Customer Center: High-tech Park, Binhu District, Wuxi, Jiangsu Province, China

Tel/Wechat: +86 18565855789

E-mail: xjlv@szgmt.com

Website: www.gmweighing.com

Technology evolves fast. Is your Checkweigher keeping pace?



Does your checkweigher provide smooth product transfer in production line?

—Today's eco-friendly packaging trends focus on being easy to grip, open, use, and reseal. Cans or bottles may be conveyed upright or lying down on production lines.



What language does the operator use?

—The checkweigher should support multiple languages.



What is the operator's skill level?

—The touchscreen interface should be easy to operate, with simple and intuitive prompts.



Do you require sound-light alarms or only basic functions?

—Buying a basic configuration and upgrading later is becoming a common trend.



Do you need to save space?

—Checkweighers and metal detectors are often used together for precise weight control and for preventing metal contamination. It is meaningful to complete two tasks with one device.



Can your checkweigher store data?

—Since the checkweigher is the last device to contact the product on the line, historical data becomes extremely valuable when problems arise.



Can your checkweigher communicate with other devices on the production line? Does it need to track every item and upload data in real time for smart analysis?

—Increasingly, production lines run multiple different brands products simultaneously.



Is your checkweigher suitable for fresh foods? Does it meet the IEC protection rating of IP65?

—Fresh foods are becoming popular, and the checkweigher you use for canned products may need an upgrade to wash-down version.



Is the checkweigher installed right before palletizing?

—Installing checkweighers at different locations enables earlier detection of unqualified products.



Do you need real-time data?

—Real-time data helps identify production issues promptly and prevents late-stage problems.



Overview of Checkweigher

A checkweigher performs dynamic weighing of each product on a production line. It classifies conforming, overweight, and underweight products, counts items, and rejects non-conforming ones. By ensuring accurate weight control, it helps you meet process requirements and regulatory standards. A checkweigher—also known as a weighing inspection machine, sorting scale, weight classifier, or inspection scale.

Why You Need a Checkweigher

Compliance with regulations and export requirements

- **The U.S. National Institute of Standards and Technology (NIST)** specifies maximum allowable variations for packaged goods.
- **The EU Measuring Instruments Directive (MID)** defines performance requirements for checkweighers used to weigh products sold to consumers.
- **China's Supervision Measures for Quantitative Packaging Commodities** and JJF 1070-2023 specify scope, metrological requirements, and inspection methods for net-content measurement.
- **Provisions on Package Inserts and Labels for Drugs:** The smallest sales package must include an insert. Missing inserts can endanger patient safety. Checkweighers prevent quantity errors, making them essential equipment in the pharmaceutical industry.
- **National Standard OIML R 51-1 for Automatic Checkweighers:** X-class is applicable to prepackaged goods under the above regulations. Since checkweighers weigh products at the center axis of motion, static corner error is only a reference factor for evaluating performance.

Ensuring product quality and protecting brand reputation

- Checkweighers ensure every consumer receives a complete product—no missing granules, capsules, injectables, inserts, or partially filled cartons—thus protecting both brand reputation and corporate profitability.

Dynamic repeatability: the key indicator of checkweigher accuracy

According to **OIML R51**, for products <1 kg:

- **General industry:** Test with conforming products at least 20 times. Data must fall within ± 2 standard deviations; verification scale interval $0.1g \leq e \leq 2g$.
- **Pharmaceuticals:** Test 25–60 times (up to 100 times). Data must fall within ± 3 standard deviations.

Standard deviation of the error (s)

- The mathematical expression of repeated automatic weighing errors for one or more loads passing across the weighing unit.

$$S = \sqrt{\frac{\sum_{i=1}^n (x_i - \bar{x})^2}{n-1}}$$

x — the error of the load

\bar{x} — average error

n — weighing times

Checkweigher Structure and Working Principle

Components

A general checkweigher includes: weighing unit, controller, reject mechanism, and conveyor system. These ensure compliant net weight and allow quality control.

Principle

The conveyor delivers the package to the weighing platform. A photoelectric sensor signals the controller when the product is in position. Once stable, the controller calculates weight and compares it with preset limits. As the conveyor carries the product away, the controller actuates a rejector if needed.

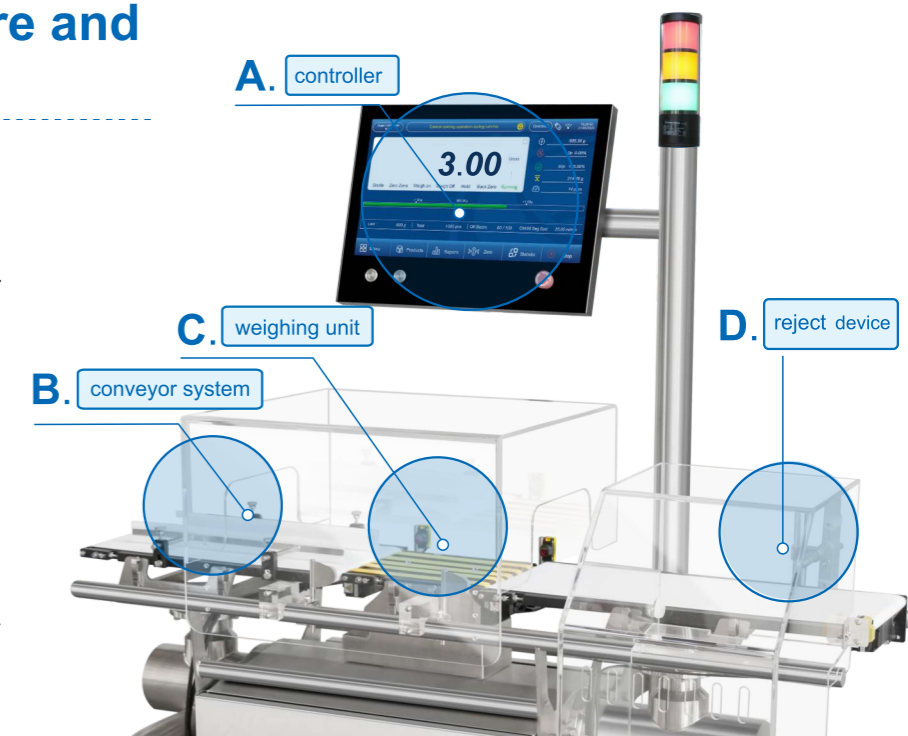

Key Installation Considerations

- Confirm conveyor spacing. Adjust line speed according to the upstream packaging rate (pcs/min). Inadequate spacing or excessive upstream speed increases checkweigher response load and reduces dynamic accuracy.
- Ideal spacing between packages must allow automatic zeroing to ensure optimal accuracy.

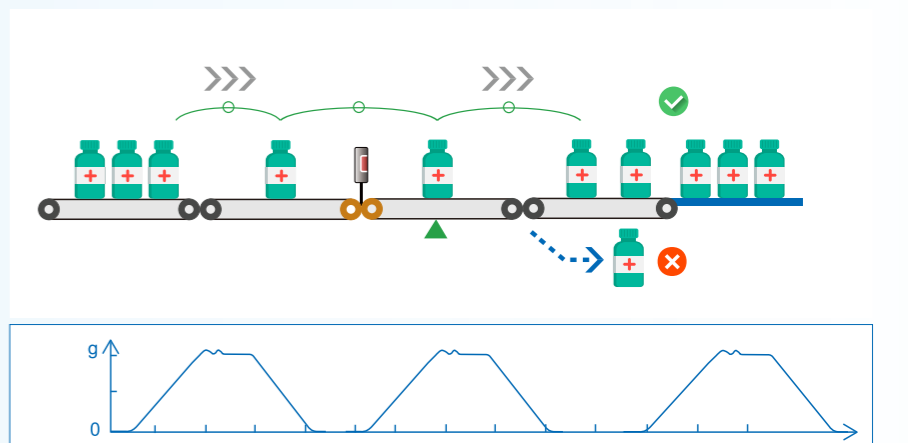

Reasonable accuracy requirements

Ensure that the weight of a single missing component dose not exceeds packaging weight deviation (packaging material deviation and product weight deviation).

$$\text{Dynamic checkweighing accuracy} = \pm \text{missing component weight} / 4$$

Example:

If the instruction leaflet weighs 1.2 g, required accuracy is: $\pm 1.2 / 4 = \pm 0.3$ g (equivalent to 3× standard deviation)

$$\text{Optimal dynamic accuracy} = \text{missing component weight} / 8$$

Spacing Devices

Depending on the packaging format, there are three spacing methods.

Vertical side belt transfer

- Stable, suitable for various bottled or filled products.

Star wheel

- For plastic bottle separation.

Wormscrew helix

- Suitable for bottled products with consistent diameters.

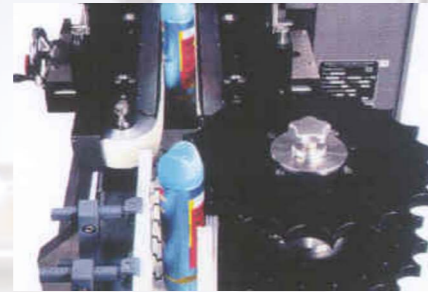

Reject Devices

The rejector is installed after the weighing platform. As the packaged products exit from the checkweigher's conveyor, non-conforming items are removed. Typical rejection methods include:

Swing arm

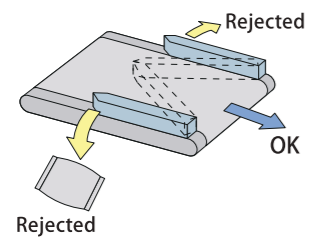

Air-jet/blast

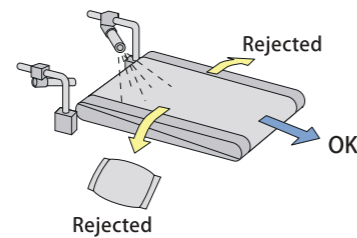

Pusher

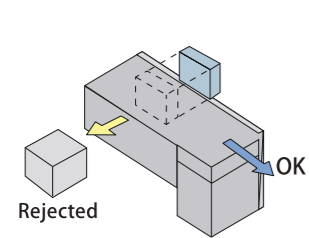

Flap conveyor

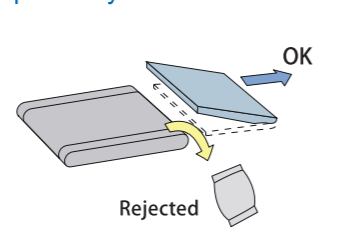

Checkweigher Precautions

✓ Allowed Operations	✗ Refused Operations
Ensure smooth product transfer.	Frequent start/stop of the production line.
Calibrate at every shift change.	Running the line for more than one hour without checking if spacing has auto-zeroed.
Choose a checkweigher that ensures.	Focusing only on the lowest price instead of total cost.
Properly tension checkweigher chains/conveyor belts.	Not allowing other conveyors to touch the checkweigher.
Provide all product and application details to suppliers when requesting a quotation	Do not let products be on the weigh table or load cell.
Set correct infeed configuration and spacing upstream to ensure accurate weighing.	Providing power or air pressure lower than the required specification.

Customized Solutions

To ensure reliable weight control and improved efficiency, consider the following factors when designing a customized solution:

- Number of weighing lanes and drive type;
- Type of conveyor belt or chain;
- Conveyor speed;
- Customized rejector design;
- Installation space and height;
- Infeed/outfeed configuration;

Failure to design properly may affect weighing performance.



Precision Control · Match All-Scenario

—General Measure Hawk & Egret Checkweigher for Industrial Upgrades

General Measure has deeply cultivated the dynamic checkweighing and developed two brand new series to meet diverse industry needs: **Hawk Series** – Designed specifically for the pharmaceutical industry. GMP compliance and pharmaceutical application compatibility safeguard drug quality. **Egret Series** – A versatile, all-scenario solution that delivers precise, efficient weight control across multiple industries.



Hawk Pharma Series



Egret Series



High speed
High accuracy



Industry standard
compliance



Durable and stable



High integration



Alarm Reminder



Easy to clean

Hawk Pharma Series

Pharmaceutical Checkweigher

Designed to meet Good Manufacturing Practice (GMP) requirements.



Hawk Pharma Series

Checkweigher designed for pharmaceutical **GMP**



High Speed, Great Efficient
400 pcs/min

Wide Weighing Range
5~600g

Display Accuracy
±10 mg

Best Accuracy
±0.1g



Hawk Pharma series checkweigher is engineered to comply with pharmaceutical GMP standards, ensuring high-precision, high-speed, and **24/7** stable dynamic weighing performance.

AI Filtering Technology

Designed for unstable products (e.g., wobbling vials, ampoules, blister packs), **AI algorithms monitor machine vibration and continuously adapt through model-based learning** to ensure accuracy even under complex conditions.

Non-contact taut belt high accuracy performance weighing platform

Using patented non-contact taut band high-accuracy technology combined with a low-friction aluminum conveyor and precision-controlled servo motor, the system ensures exceptional accuracy on high-speed production lines.

High-Performance Weighing

Weighing range: **5~600g**; Up to **400** ppm depending on packaging size; Suitable for small-dose or medium-size pharmaceutical packages.



FDA Approval



3Q Documentary



Factory Acceptance Test

Compliance with Pharmaceutical Regulatory Requirements

- Supports accurate and repeatable dynamic weight measurement. Provides required certifications and supports **FDA 21 CFR Part 11** audit trail.
- Offers fail-safe rejectors, reject verification, open-flap detection, and more.



Stable and Precise Performance

Flexible and Convenient

- Compact design with adjustable height, easy to integrate with cartoners;
- Modular weighing unit for easy installation and maintenance;
- Touchscreen with 30° tilt for ergonomic operation;



30° vertical flip



Durable and Reliable

- Industrial-grade materials and maintenance-free key components reduce the downtime for equipment maintenance. Designed for 24/7 continuous operation.

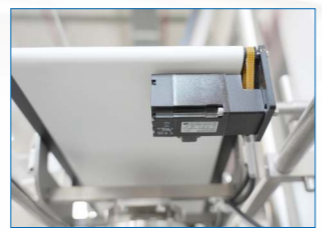

Hygienic Design

- GMP-compliant structure with smooth surfaces for easy cleaning meet the requirements of clean production environments to avoid the risk of cross-contamination.



Air draft cover

- Prevents air turbulence and vibration interference;
- Blocks dust contamination, avoid cross-contamination;
- Transparent for real-time production monitoring.

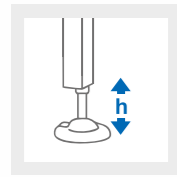

Height adjustable



Smart and User-Friendly Operation

User-Friendly Interface

- 15.6-inch full-color touchscreen, editable, intuitive UI;
- One-touch style switching and real-time statistics;



Intelligent Learning



- AI-based intelligent dynamic filtering; automatic optimization;

Data Analytics

- Multiple big-data analysis dashboards; Real-time production trend monitoring with SPC;
- Up to 200 product recipes improve the efficiency of production turnover;
- 400 GB data storage for full traceability;



Product	Recipe Name	Weight (g)	Count	Unit	Weight (g)	Count	Unit
Product 1	Recipe 1	1.000	1000	1000	1.000	1000	1000
	Recipe 2	1.000	1000	1000	1.000	1000	1000
Product 2	Recipe 3	1.000	1000	1000	1.000	1000	1000
	Recipe 4	1.000	1000	1000	1.000	1000	1000

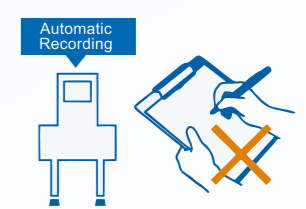

Application Flexibility

— for pharmaceutical packaging of various forms

Hawk Pharma can weigh diverse pharmaceutical packaging, and through precise weight analysis to achieve the quality control.

Packaging type • cartons, glass/plastic bottles, sachets, film packs;

- ✔ Detects missing inserts (e.g., mandatory drug leaflets);
- ✔ Detects missing tablets/capsules or insufficient filling;



Technical Specifications

Model	Hawk Pharma
Weight Range	5~600g (0.011~1.32lb)
Top Speed	400 ppm
Best Accuracy	±0.1g
Motor	Servo Motor
Structure	SS304 / Aluminum
Operating Temperature	0°C~+45°C (+32°F~+113°F)
Humidity	20%~90%, Non- condensing
Power Supply	90-250 VAC, 50/60 HZ 5A
Air Supply	5.5-6.9 bar (80-100 psi)
IP Grade	IP54
Line Height	830mm(24.8 inch)~1150mm(45.3 inch)
Communication	RS232/422/485, Allen Bradley Remote I/O, Ethernet TCP/IP, Modbus RTU, Modbus TCP/IP

1. The actual accuracy depends on the product's length, weight, speed and stability.
2. The push rejector needs an independent conveying device, and the cantilever length of the conveyor should not exceed 1250mm (combined configuration).

Dimensions (Unit: mm)

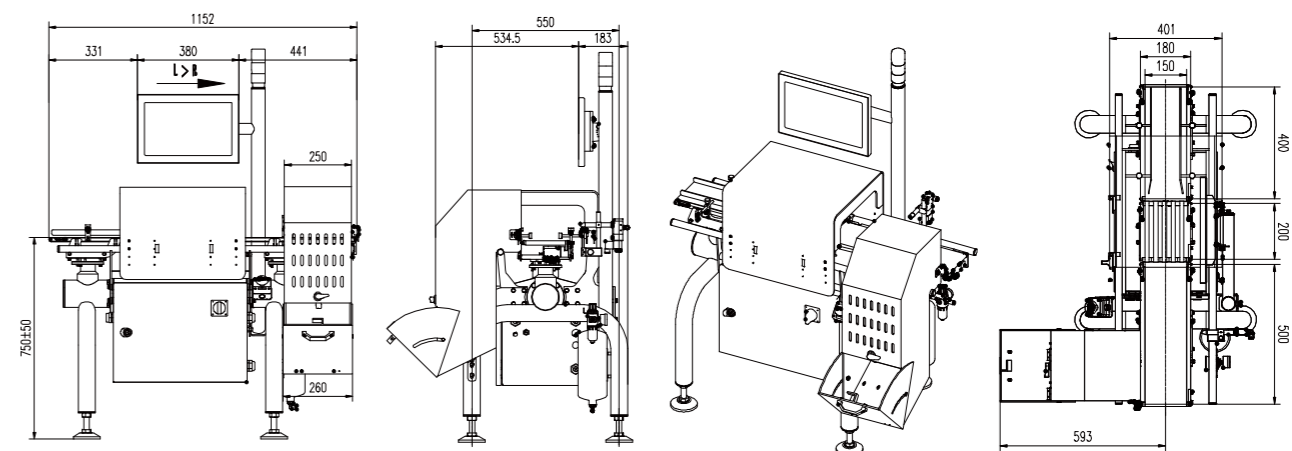

*Parameters and dimensions may be upgraded. Please consult in real time for the latest information.

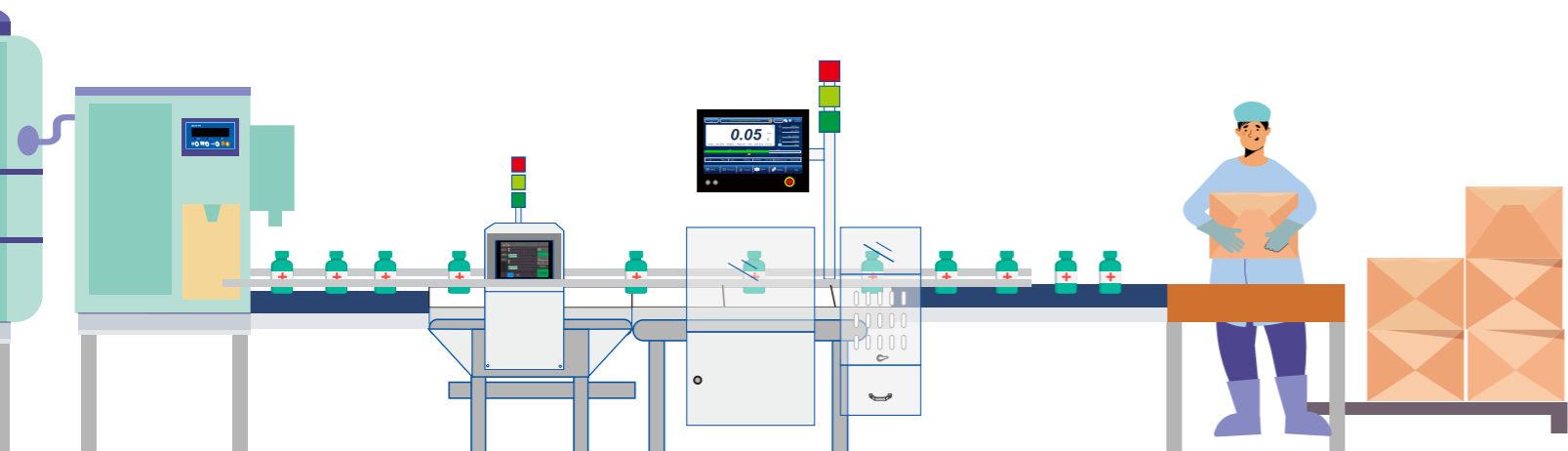



Egret Series

Versatile Checkweigher

High Speed, Great Efficient

 **250** pcs/min

Wide Weighing Range

 **20~1500g**

Display Accuracy	Best Accuracy
 ±0.1g	±0.3g



Designed to enhance efficiency and reduce costs, Egret delivers high precision, ease of use, and strong adaptability across industries.

Precision and Stability

Patented floating taut band weightable; supports up to 400 ppm with automated rejection for weighing, rejecting non-conforming product and quality controlling.

Easy Maintenance

Hygienic round-tube frame, **IP65 washdown**, food-grade design, compact layout, adjustable height for online weighing applications in various industrial settings.

Cross-Industry Compatibility

Suitable for dry and wet environments: food, pharma, personal care, chemicals, petrochemicals, rubber, automotive, new energy, consumer goods, and more. full coverage of weight control across all industries.



Food Industry



Pharmaceutical Industry

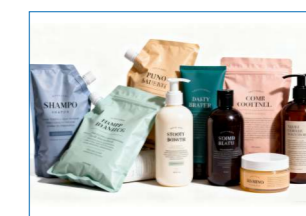

Personal Care



Meat Industry

Egret Series

Versatile Checkweigher



Stable and Precise Performance

High Precision

- Photoelectric sensors detect product position. It can maintain excellent precision even at high speeds.
- **AI dynamic learning** simplifies installation and setup.

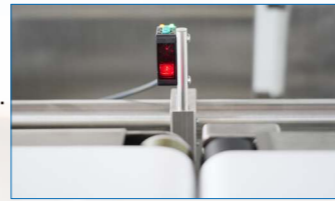

Stable and Durability

- Full stainless-steel construction, robust and durable.



- High-torque sealed servo motors with minimal maintenance.



Hygienic Design

- Compact, small footprint; Cleanable in under **5** minutes.
- Smooth surfaces reduce dirt accumulation and clogging risk.



Easy Maintenance

- Tool-free conveyor and belt replacement. Quick-connect cables and modular electronics enable maintenance within **15** minutes.

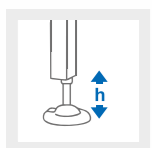

Height adjustable



Smart and User-Friendly Operation

User-Friendly Interface

- Proprietary operating system, safe and reliable.
- **15-inch** touchscreen;
- The graphical interface is intuitive and user-friendly;
- Multi-language support and permission control.



Intelligent Learning

- **AI-based** intelligent dynamic filtering; automatic optimization;



Data Analytics

- Multiple big-data analysis dashboards; Real-time production trend monitoring with **SPC**;

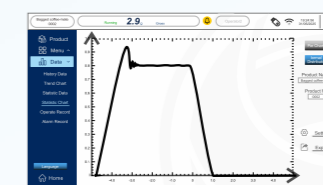

Sampling Time Control

- Adaptive sampling settings for different product types;
- Scenario-based visualization to improve accuracy and efficiency.

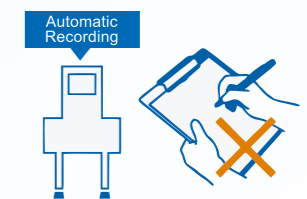
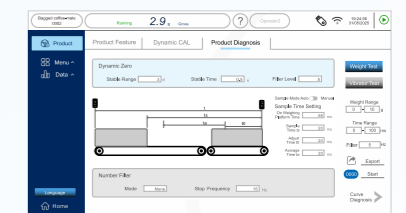

All-in-One Inspection Upgrade Solution

To enhance end-to-end quality control, the Egret series can be seamlessly integrated with General Measure's **Kestrel 500** or **Plover 100** metal detectors. This combination forms a unified workstation that delivers both precise weight control and metal contamination detection, significantly improving production efficiency and product qualification rates.



Kestrel 500 metal detector



Plover 100 metal detector

Embedded Integration

- The checkweighing module can be flexibly embedded into large upstream or downstream packaging or filling systems. Guided by external control units, it divert qualified and unqualified products, enabling efficient, streamlined production line management.

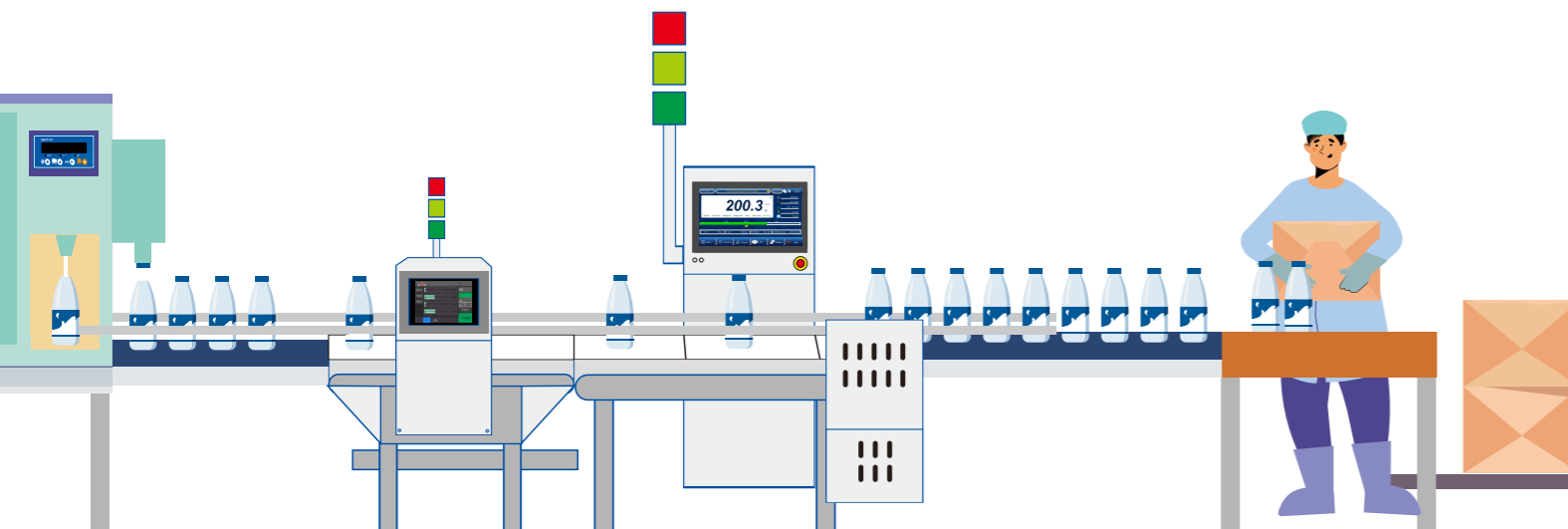

Technical Specifications

Model	Egret C-200
Weight Range	20~1,500g (0.044~3.31lb)
Speed	250 ppm
Accuracy	±0.3g
Motor	Servo Motor
Structure	SS304 / Aluminum
IP Grade	Standard IP65
Operating Temperature	0°C~+45°C (+32°F~+113°F)
Humidity	20%~90% , Non- condensing
Power Supply	90-250 VAC, 50/60 HZ 5A
Air Supply	5.5-6.9 bar (80-100 psi)
Line Height	830mm(24.8 inch)~1150mm(45.3 inch)
Communication	RS232/422/485, Allen Bradley Remote I/O, Ethernet TCP/IP, Modbus RTU, Modbus TCP/IP

- The actual accuracy depends on the product's length, weight, speed and stability.
- The push rejector needs an independent conveying device, and the cantilever length of the conveyor should not exceed 1250mm (combined configuration).

Dimensions (Unit: mm)

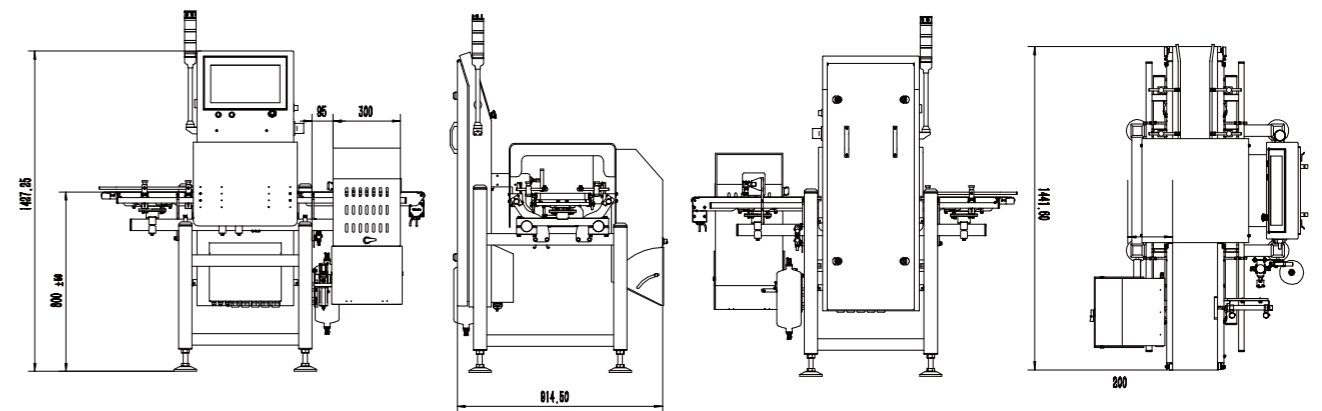

*Parameters and dimensions may be upgraded. Please consult in real time for the latest information.

Metal Detection System (Checkweigher & Metal Detector Combo)

Full-Process Protection with Highly Integrated Solutions

General Measure's metal detector provide reliable and cost-effective protection, accurately detecting various types of metallic contaminants throughout the food manufacturing process and minimizing quality risks. This system significantly enhances operational efficiency and reduces losses caused by metal contamination, helping companies achieve quality assurance and cost control.



High Sensitivity



High Integration



Alarm Reminder



Easy to Clean

Designed for the demanding environments of food processing and packaging, multiple metal detector models tailored for different applications. When seamlessly integrated with GM's checkweighers, it forms a fully unified end-of-line quality control solution, reducing total footprint while enabling centralized management of program changes, alarms, rejection statistics, and more.

Operation is highly flexible—users may operate via the metal detector's front panel or through the touchscreen interface on the checkweigher.

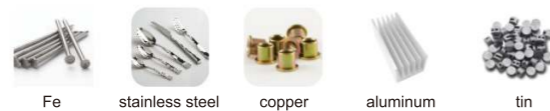

Plover 100 Metal Detector



Kestrel 500 High-Performance Metal Detector



- Features ultra-high **IP69K** protection, resistant to thermal shock and strong acidic chemicals.

Plover 100 Metal Detector

Model	2508	2510	2515	2520	2525	2530	
Detection Width	250mm						
Detection Height	80mm	100mm	150mm	200mm	250mm	300mm	
Sensitivity (No Product)	Fe	φ 0.5mm	φ 0.7mm	φ 0.7mm	φ 0.8mm	φ 1.0mm	φ 1.5mm
	SUS304	φ 1.2mm	φ 1.2mm	φ 1.5mm	φ 2.0mm	φ 2.5mm	φ 3.0mm
Belt Width	Standard 220mm/200-250mm (Customizable)						
Platform Height	750±50mm						
Load Capacity	10kg						
Belt Speed	29m/min (Customizable)						
Belt Material	Food-grade PU or PVC						
Display	LCD control panel (optional 7" color touchscreen)						
Power Supply	AC220V 50-60Hz (Customizable)						
Response	Metal detected → alarm & belt stop (alarm / rejector optional)						
Structure	SS304						

Kestrel 500 High-Performance Metal Detector

Model	Kestrel 500
Speed	0.5 m/min(1.7ft/min) to 100m/min (330 ft/min)
Communication	Optional Modbus RTU or Standard Ethernet
Structure	SS304 brushed housing, ABS plastic casing
Power Requirements	85/250V AC, single-phase, grounded; 47/85Hz, 150W(Max)
Applicable Range	Food, beverage, and general product metal detection
IP Grade	IP69K
Inputs	feeding PEC, rejection confirmation and bin full, external suppression, external detonation and external reset
Input Ports	6 inputs supporting 12 VDC and auxiliary power for sensors and NPN/PNP signals
Operating Temperature	Ambient: -10°~ 40°C (14°~104°F); Product: -10°~ 55°C (14°~ 131°F); Max Storage Temp: 80°C (176°F)
Outputs	Reject 1, Reject 2, Fault, Alarm, Warning, GM Order
Output Types	6 relay outputs, Relay: 250V AC, 2A (max), 50V DC, 13W (max)
Sensitivity	Fe: φ0.5mm NON-Fe: φ0.5mm SUS316: φ0.8mm (The smaller opening is, the higher the detection difficulty will be)

ABOUT GENERAL MEASURE

30+ years in weighing industry,
Leading global dynamic weighing technology.



30+ years

Industrial Weighing
Experience



50+

Countries Sales



300,000+ units

Annual Sales

General Measure was established in **1993** in **Shenzhen**, China. GM is a professional brand specializing in dynamic weighing. As one of China's earliest industrial weighing companies, GM has an R&D team of over **60** engineers. For more than **30** years, GM has been committed to improving industrial weighing automation and the precision of weighing control.

—A journey from China to the global stage.

1988~1993

Company co-founders Mr. Su and Mr. Liu began developing electronic weighing indicators in China. In 1993, General Measure was officially established.

2003~2013

GM achieved major breakthroughs in high-speed weighing and anti-vibration precision technologies. The mechanical division was established, and GM started to enter the global market.

2017~Future

A new production center was built in **Zhuzhou**. A global partnership system was established.

GM continued expanding its international market and service capabilities.

Core Business:

Focused on Dynamic Weighing with Strict Product Standards

General Measure is dedicated to the R&D, production, and sales of dynamic weighing indicators, dynamic checkweighers, and granular packing scales. All products are developed and manufactured in accordance with international standards.

General Measure is recognized as a National High-Tech Enterprise, and qualified with **ISO9001**, holding over **300** intellectual property patents.

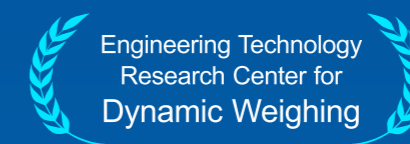

300+

Patents



10,000+m²

Production Base

SINCE

1993



Global layout:

Multiple certifications help our products reach global markets



Market Reach

Products exported to over **50** countries and regions, recognized by industry-leading customers worldwide.

Service Capabilities:



30+years of weighing expertise

Providing professional solutions across diverse industries.



Professional service support

Including training, maintenance, new-product onboarding, and remote assistance.



Custom design services

Offering **OEM** solutions such as labels, appearance customization, and multilingual interface development.

Corporate Culture:



STRATEGIC VISION

To be a respectable and sustainable enterprise for serving the global by intelligent weighing products and solution.



MISSION

Combining cutting-edge technology to disrupting the industry status-quo, making weighing more accessible.



VALUE



Listening



Innovating



Growing Together