

GMC-P7(F8)

Touch Screen Weighing Controller

(Manual Batching & Formulation)

High-efficient, competitive Easy operation, user-friendly

The GMC-P7(F8) is a desktop high-precision manual batching controller equipped with a 7-inch touch screen. The intuitive touchscreen and the visual batching process make it clear and convenient to use. The upgraded weighing filtering algorithm and optimized A/D conversion speed ensure stable and efficient weighing.



FEATURES & FUNCTIONS

- 7-inch touch screen, intuitive display, better interaction, easy operation;
- Stainless steel, front panel IP65, strong anti-interference;
- **10** recipes to switch;
- **1 million** entries storage, USB for exporting data;
- Micro printer and EPSON serial printer is available, 3 different formats of printing contents;
- Standard 5 IN/5 OUT I/O ports;
- IO testing function and serial port testing function facilitate user debugging;
- The visual manual batching process is user-friendly;
- Automatic taring after startup;
- Multilevel user authority management(operator, Technician);
- Dual filtering function solves of data hopping;
- Boot screen customization.

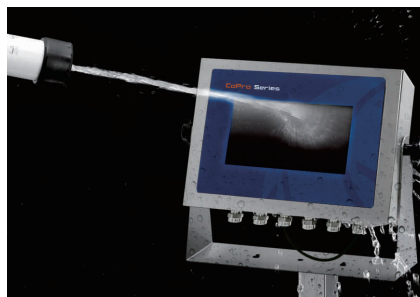

Manual Batching & Formulation



- Display style switching;
- Flexibly adapted to usage scenarios and operational requirements;
- Delivering a more efficient and user-friendly operation experience.



Underweight



Qualified weight



Overweight

- **Style 1**: progress bar indicates batching process

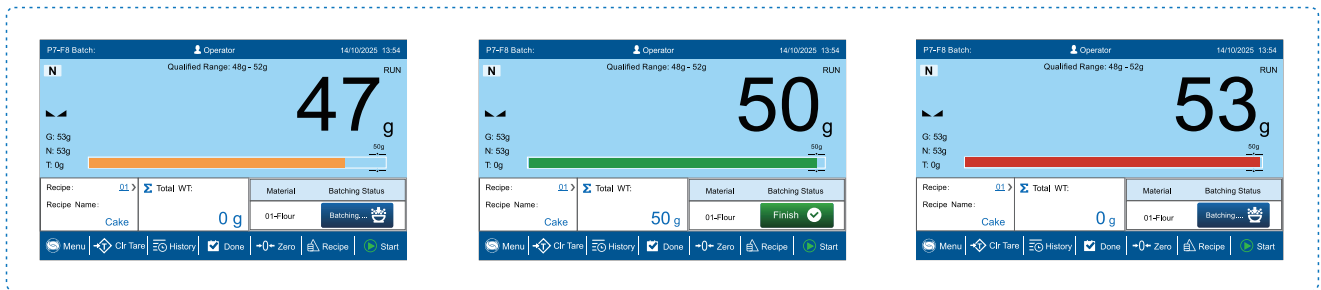

- **Style 2**: background color indicates results

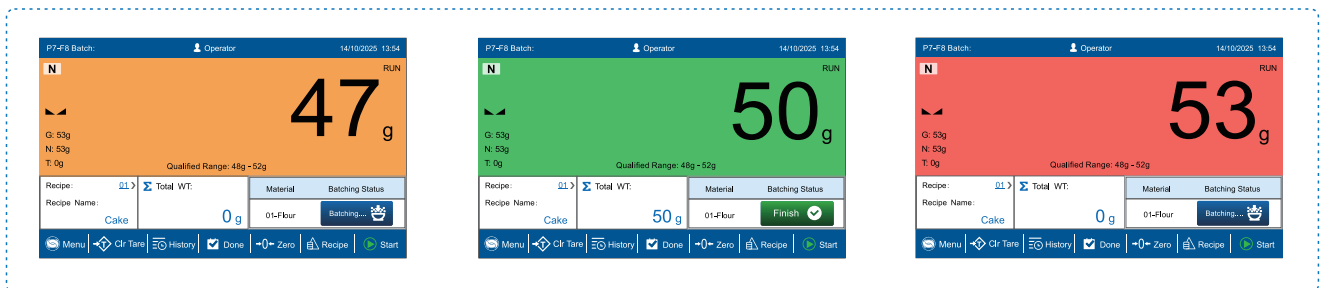

User Management

- **2-level authority**: operation and technician;
Prevent operators from modifying parameters.

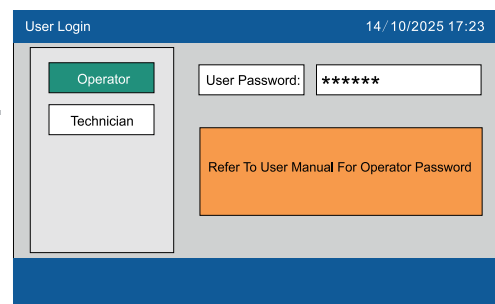

Recipe Function

- 10 recipes, each recipe contains 20 materials, including target weight and tolerance.

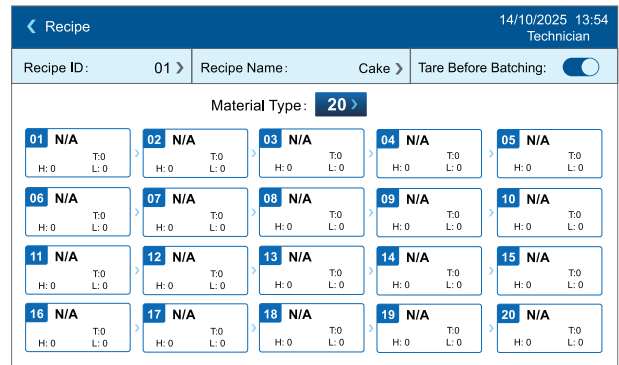

- E.g. cake material:

1. Flour 50g
2. Egg 150g
3. Milk 35g
4. Sugar 45g

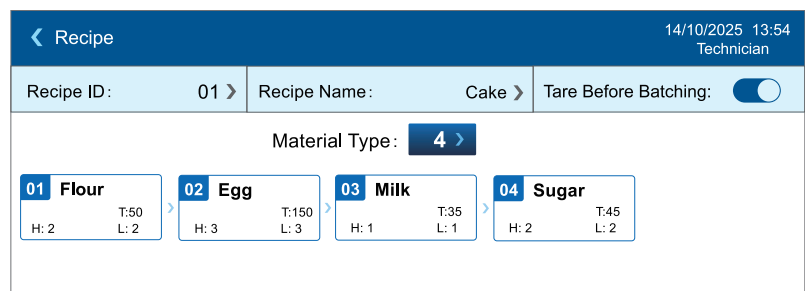

Manual Batching Process

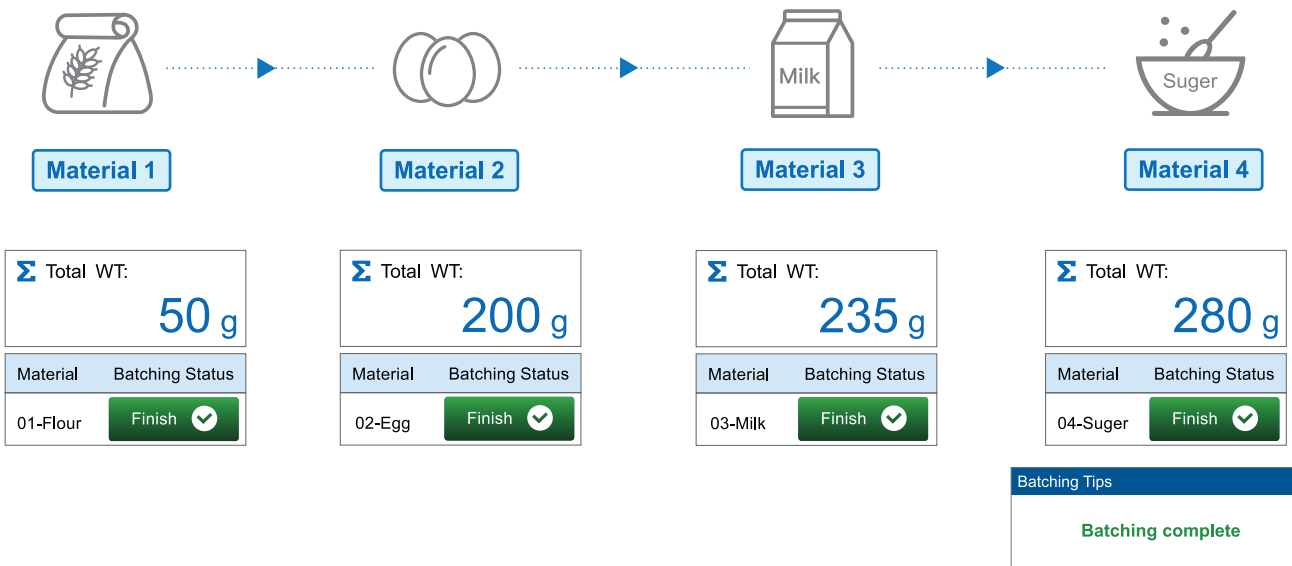

- User-friendly batching process display and prompts.

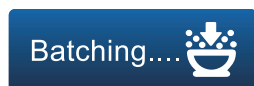

Report Function

< History Data 14/10/2025 17:38
Operator

No.	Recipe ID	Recipe Name	Total WT	Tare	Net	Start Time
1	1	Cake	279g	80g	279g	14/10/2025
2	1	Cake	281g	80g	281g	14/10/2025
3	1	Cake	280g	80g	280g	14/10/2025
4						
5						
6						

U Disk Export Clear Data

- **1 million** entries storage, including recipe ID, name and materials, weight, time, duration, upper limit and lower limit.

- USB for exporting the history data.

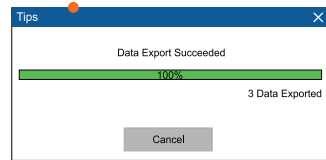

WGS_TIME	WGS_TIMER	Recipe_ID	recipe_No	Total_WT	Tare	Net	Start_Time	End_Time	Total_Time	Material_No	Real_WT1	Target1	Up_Limit1	Low_Limit1	Material_No	Real_WT2	Target2	Up_Limit2	Low_Limit2	Material_No	Real_WT3	Target3	Up_Limit3	Low_Limit3	Material_No	Real_WT4	Target4	Up_Limit4	Low_Limit4
2025/12/18 17:17	297	1	Cake	279 g	80 g	279 g	17:17:19	17:17:53	34 s	Flour	49 g	50 g	2 g	2 g	Egg	150 g	150 g	3 g	3 g	Milk	35 g	35 g	1 g	0 g	Super	45 g	45 g	2 g	2 g
2025/12/18 17:26	617	1	Cake	281 g	80 g	281 g	17:26:15	17:26:52	37 s	Flour	51 g	50 g	2 g	2 g	Egg	150 g	150 g	3 g	3 g	Milk	35 g	35 g	1 g	1 g	Super	45 g	45 g	2 g	2 g
2025/12/18 17:38	799	1	Cake	280 g	80 g	280 g	17:37:54	17:38:25	31 s	Flour	50 g	50 g	2 g	2 g	Egg	150 g	150 g	3 g	3 g	Milk	35 g	35 g	1 g	1 g	Super	45 g	45 g	2 g	2 g

Printing Function

- Support micro printer and EPSON serial printer;
- Available for Chinese/English printing;
- **standard / simple1 / simple2**
3 different formats of printing contents;

Simple 1

Recipe name	Cake
Tgt. value	+280 g
Act. value	+280 g
Net weight	+280 g
Gross weight	+360 g
Date	14/10/2025

Simple 2

Recipe name	Cake
Tgt. value	+280 g
Act. value	+280 g
Net weight	+280 g
Gross weight	+360 g
Date	14/10/2025
Material1	Flour
Tgt. value	+50 g
Act. value	+50 g
Material2	Egg
Tgt. value	+150 g
Act. value	+150 g
Material3	Milk
Tgt. value	+35 g
Act. value	+35 g
Material4	Suger
Tgt. value	+45 g
Act. value	+45 g

Standard

Recipe name	Cake
Tgt. value	+280 g
Act. value	+280 g
Net weight	+280 g
Gross weight	+360 g
Date	14/10/2025
Start time	17:37:54
Final time	17:38:25
Spent	31s
Material1	Flour
Tgt. value	+50 g
Act. value	+50 g
Material2	Egg
Tgt. value	+150 g
Act. value	+150 g
Material3	Milk
Tgt. value	+35 g
Act. value	+35 g
Material4	Suger
Tgt. value	+45 g
Act. value	+45 g

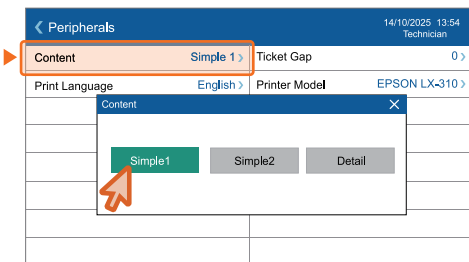

I/O Function

< I/O					14/10/2025 13:54
					Technician
Input >	IN1	Zero >	Low_Level >	5ms >	
	IN2	Print >	Low_Level >	5ms >	
	IN3	Feed Paper >	Low_Level >	5ms >	
Output	IN4	Start >	Low_Level >	5ms >	
	IN5	Stop >	Low_Level >	5ms >	

< I/O					14/10/2025 13:54
					Technician
Input	OUT1	Stable >	Low_Level >		
	OUT2	Zero >	Low_Level >		
	OUT3	Net >	Low_Level >		
Output >	OUT4	Batching >	Low_Level >		
	OUT5	Over >	Low_Level >		
I/O Test	OUT6(R)	Pass >			
	OUT7(R)	Under >			
	OUT8(R)	Material Done >			
	OUT9(R)				

< I/O					14/10/2025 13:54
					Technician
Input	OUT1	<input type="checkbox"/>	IN1	<input type="checkbox"/>	
	OUT2	<input type="checkbox"/>	IN2	<input type="checkbox"/>	
	OUT3	<input type="checkbox"/>	IN3	<input type="checkbox"/>	
Output	OUT4	<input type="checkbox"/>	IN4	<input type="checkbox"/>	
	OUT5	<input type="checkbox"/>	IN5	<input type="checkbox"/>	
I/O Test >	OUT6(R)	<input type="checkbox"/>			
	OUT7(R)	<input type="checkbox"/>			
	OUT8(R)	<input type="checkbox"/>			
	OUT9(R)	<input type="checkbox"/>			Test Switch <input checked="" type="checkbox"/>

- Standard 5 inputs 5 outputs I/O , optional 4 relay outputs;
- Support I/O testing funtions;

Boot Screen Function

- **7-inch touch color screen:**
High definition interface visualization operation, supporting custom startup logo.



HARDWARE CONFIGURATION



Standard:

- 5 input (TTL), 5 output (TTL),
I/O position can be customized;
- 2 RS485 and 1 RS232;

Options:

- Modbus TCP;
- 4 relay output;

Dimension

Unit:mm

Panel Enclosure

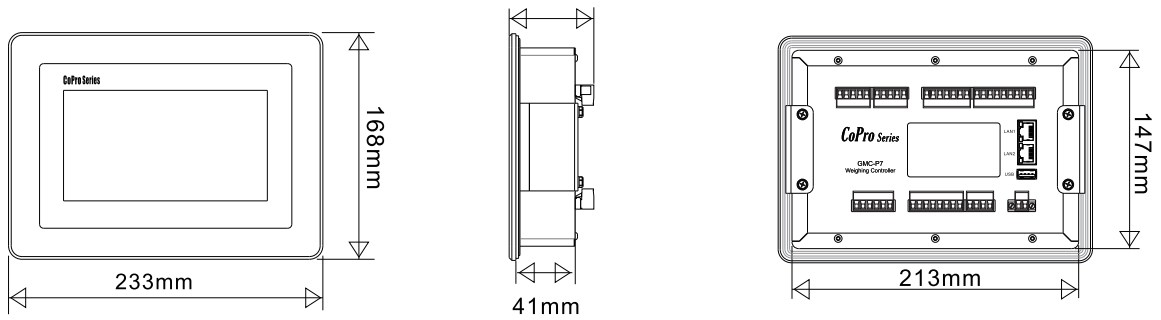

Harsh Enclosure

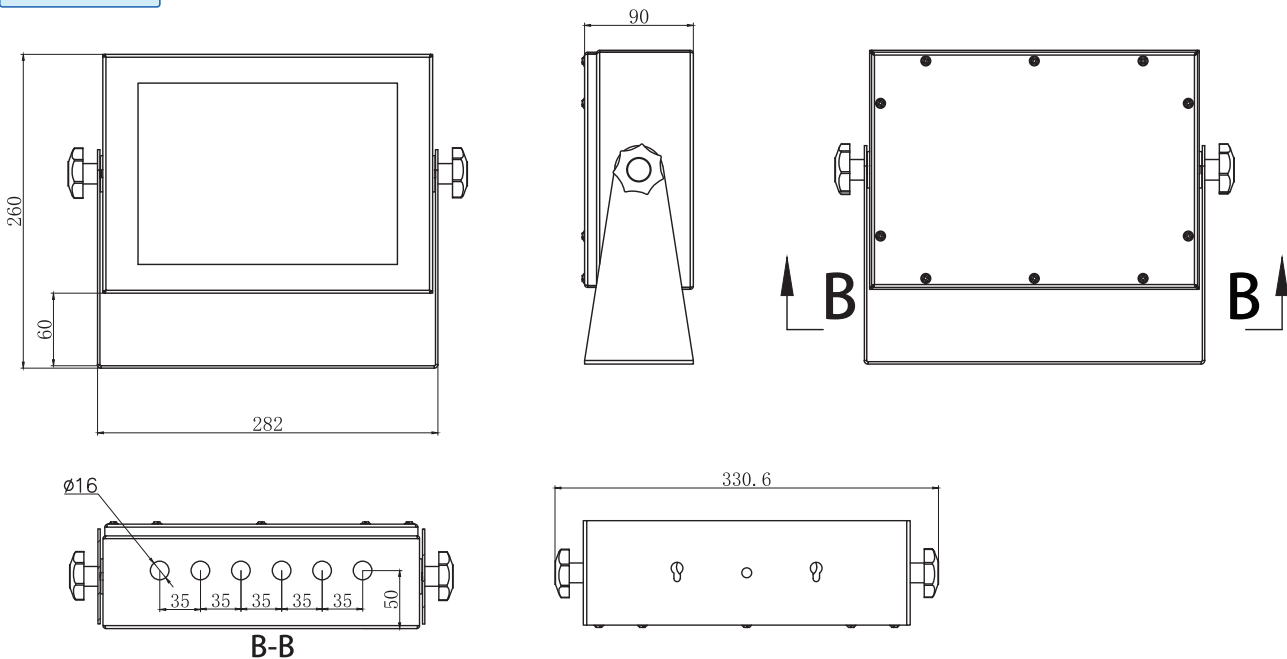

Standard Specification

General Specifications	Model	GMC-P7 F8 (Manual Batching & Formulation)
	Power Supply	DC 24V±5%
	Working temperature	-10°C~40°C
	Maximum humidity	90% RH.without dew
	Testing standards	Class III 6000 e,1μV/d
	Power consumption	About 15W
Measurement Parameters	A/D performance	24 bit Delta-Sigma
	A/D conversion speed	50~960 times/per second
	Non-linearity	0.01%F.S
	Gain drift	10PPM/C
	Input sensitivity	0.02μV/d
	Input range	0.02~15mV
	Display Accuracy	1/100,000
	Sensor power supply	DC 5V 125mA(Max)
	Input impedance	10MΩ
	Zero steady range	Maximum 0.002 ~ 15mV(Load Cell 3mV/V)

Application



Weighing scale



- Available for simple manual batching.
- Available to connect external devices.

Printer



General Measure Technology Co.,Ltd.

Address: Room2208, Block A, Building 6, Shenzhen International Innovation Valley,
Nanshan District, Shenzhen, Guangdong Province, P.R.China.
Tel/Wechat: +86 185 6585 5789
E-mail: xjlv@szgmt.com
Website: www.gmweighing.com



Linkedin



Facebook



Wechat